



VSCAN NDT*PRO* **Industrial Film Digitizer**

Installation Guide
For Use with Windows 7, 8, & 10
(Serial Numbers 371,000 to 379,999)



Iberis Software S.L.
Av. Flórez Estrada, 9, office 1A
33180 Noreña, Asturias, Spain

Phone: +34 984 030 851
Internet: www.iberisoft.com

Technical Support:
E-mail: support@iberisoft.com

Caution: No operator-serviceable parts inside. Refer servicing to qualified personnel.

Achtung: Gehäuse nicht öffnen. Wartung und Reparatur nur durch Elektrofachkräfte.

Attention: Aucune pièce ne peut être remplacée par l'utilisateur. Toute opération de maintenance doit être effectuée par une personne qualifiée.

Atencion: Acceso interno solo autorizado a personal técnico cualificado.

Attenzione: Non aprire. Rivolgersi a personale qualificato.

Radio Frequency Emissions

This equipment has been tested and found to comply with the limits for a Class A digital device, pursuant to Part 15 of the FCC Rules. These limits are designed to provide reasonable protection against harmful interference when the equipment is operated in a commercial environment. This equipment generates, uses, and can radiate radio frequency energy and, if not installed and used in accordance with the instruction manual, may cause harmful interference to radio communications. Operation of this equipment in a residential area can cause harmful interference, in which case the user will be required to correct the interference at his or her own expense.

Product compliance testing was conducted using VSCAN shielded cables. Modifications to the digitizer or the VSCAN shielded cables or the use of cables other than those available from VSCAN could void the user's authority to operate the equipment.

Acceptable shipping conditions

- Temperature: -18° to $+60^{\circ}\text{C}$ (0° to $+140^{\circ}\text{F}$)
- Relative humidity: 20% to 85%, non-condensing
- Atmospheric pressure: 500 to 1060hPa (+18,000 to -1,200ft)

Operating conditions

- Temperature: 10°C to 30°C (60°F to 85°F)
- Relative humidity: 20% to 85%, non-condensing
- Atmospheric pressure: 696 to 1013hPa (10,000 to 0 ft)

Electrical supply

- Voltage: 100 to 240 VAC
- Current: 0.75 to 1.5 A
- Frequency: 47 to 63 Hz

Safety and compliance information



Accessory equipment connected to the analog and digital interfaces must be certified according to the respective IEC standards (i.e. IEC 60950 for data processing equipment).

This product is rated for continuous use.

This product is in the Ordinary Equipment Class. It provides no protection against the ingress of water.

This product is not suitable for use in the presence of flammable anesthetic mixtures with air or with oxygen or with nitrous oxide.

WARNING: To avoid the risk of electric shock, this equipment must only be connected to a supply mains with protective earth.

WARNING: Do not modify this equipment without authorization of the manufacturer.

Do not position the product so that it is difficult to access the disconnect switch (power switch) on the back of the unit.

Mains power may be removed from the product by turning off the power switch on the back of the unit.

Power cords used with this device in North America must be rated by Underwriters Laboratories for hospital use.

Power cords used with this device in Europe must meet the requirements of IEC 227 Designation 53 or IEC 245 Designation 53.

Correct and safe operation of the digitizer requires familiarity with information that is not marked on the product. The following symbols indicate that the operator should consult the manual for additional information:



This Class 1 LED device is safe under reasonably foreseeable conditions of operation.

The LED illumination system consists of 16 Class 1 LEDs, a mirror system to spread the light, and a diffuser to distribute the light approximately uniformly across an area of 2.4 sq. in (15.5 sq. cm). Light from the LED illuminator may be indirectly observed in the digitizer's film entry and exit areas.

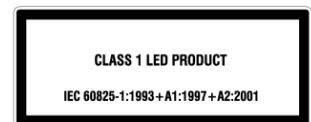

Table of Contents

Intended Use.....	6
Unpack.....	7
1. Look for Damage.....	7
2. Unpack the shipping carton	8
3. Unpack the Accessory Box.....	9
4. Unwrap	10
5. Identify the Components.....	11
6. If Anything Is Missing.....	12
Setting Up	13
1. Identify Important Features.....	14
2. Assemble the Digitizer.....	15
3. Connect the Power Cord	20
Device Driver Installation.....	21
Install Device Drivers for Windows 7, 8, and 10.....	21
1. Apply Power to the Digitizer.....	21
2. About the VSCAN Drivers	22
3. Install the VSCAN Drivers	22
Appendix: Electromagnetic Guidance	26
Appendix: Symbols	30

Intended Use

The *NDTPRO* Industrial Film Digitizer is intended for making digital copies of x-ray films for non-destructive testing applications. This device is not intended for medical use.

Unpack

In this chapter, you will:

- Unpack and inspect the digitizer's parts.
- Identify the digitizer's parts.

1. Look for Damage

Before unpacking the Digitizer, examine the shipping carton for damage.

If the carton is damaged:

- Notify the shipper immediately.
- Take photographs of the damage.
- Send pictures and description of damage to: support@iberisoft.com.
- Notify VSCAN Support at +34 984 030 851.

2. Unpack the shipping carton

IMPORTANT: Save all the packing materials. If you need to ship the digitizer later, you should repack the digitizer in the original materials by reversing the procedure described here. Failure to properly pack, or failure to use VSCAN authorized shipping materials, will void the product's warranty, and will likely result in costly repairs.

Remove items from the shipping carton in the order shown below.

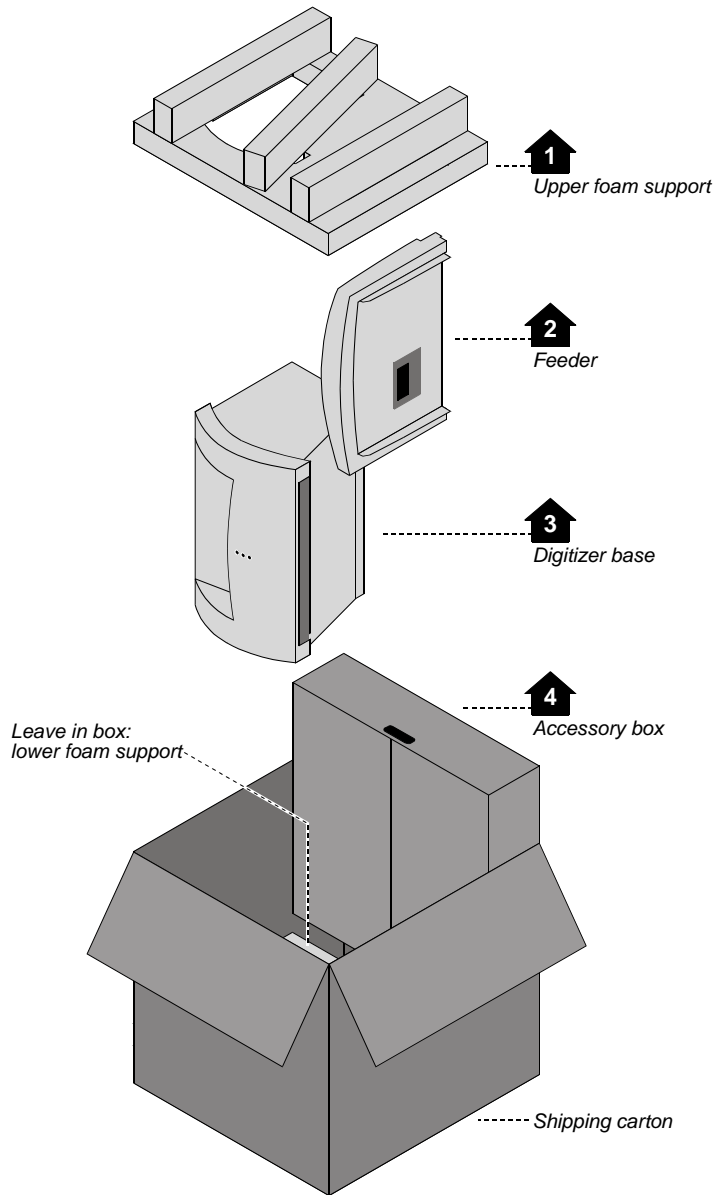

Note: For clarity, this illustration does not show the plastic bags surrounding the digitizer and feeder.

IMPORTANT: Save all the packing materials. If you need to ship the digitizer later, you should repack the digitizer in the original materials by reversing the procedure described here. Failure to properly pack, or failure to use VSCAN authorized shipping materials, will void the product's warranty, and will likely result in costly repairs.

3. Unpack the Accessory Box

a. Remove these items from the accessory box:

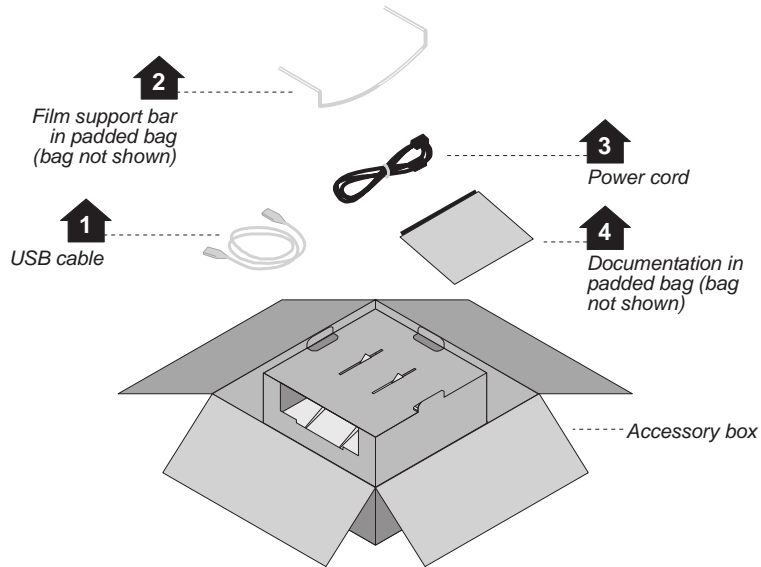

b. Then remove these items from the accessory box:

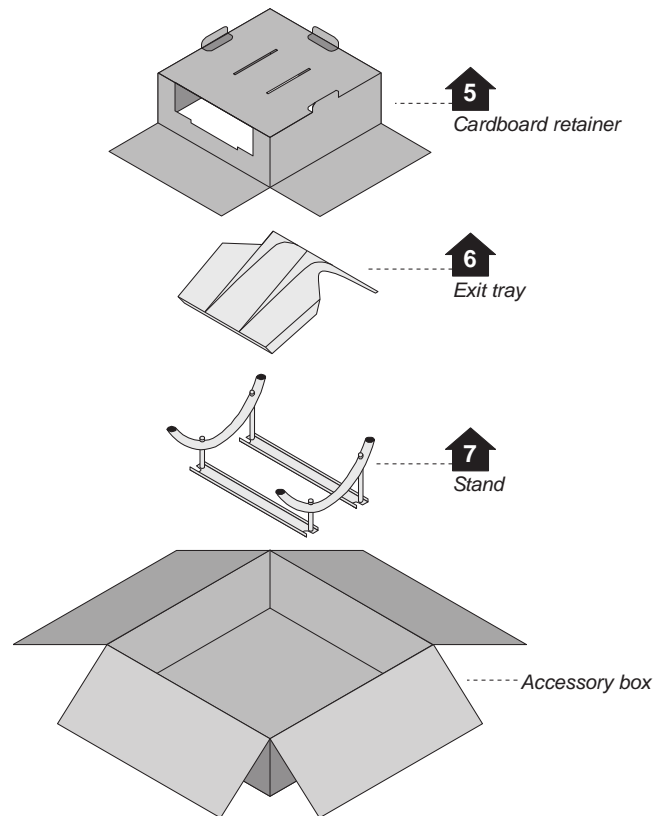

Note: For clarity, this illustration does not show the plastic bag surrounding the exit tray.

4. Unwrap

a. Unwrap all items.

b. Remove the foam block from the rear of the digitizer base:

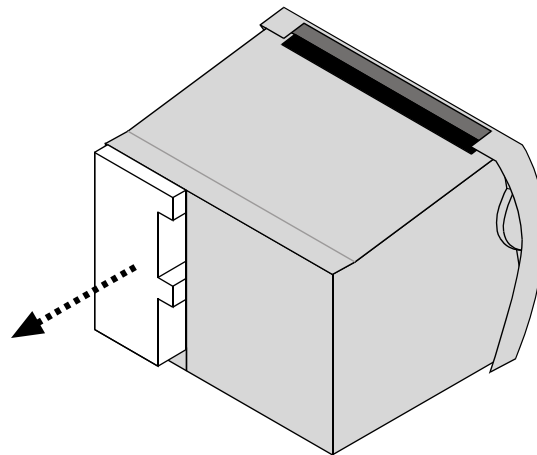

IMPORTANT: Save the carton and all packing materials. If you need to ship the digitizer later, you **must** repack it using the original wire ties, plastic bags, foam supports and cartons. Instructions for repacking are provided in the "Packing the film digitizer for shipment" section of the User's Guide.

5. Identify the Components

✓	Item
<input type="checkbox"/>	Digitizer base
<input type="checkbox"/>	Exit tray
<input type="checkbox"/>	Film feeder
<input type="checkbox"/>	Film support bar
<input type="checkbox"/>	Stand
<input type="checkbox"/>	Power cord: 115V or 230V
<input type="checkbox"/>	Quick Setup Guide
<input type="checkbox"/>	USB cable: 6 foot
<input type="checkbox"/>	VSCAN NDTPRO Industrial Film Digitizer CD



Digitizer Base



Film Feeder



Film Support bar



Stand



Exit Tray

6. If Anything Is Missing...

Immediately contact your VSCAN supplier.

NEXT: Go to “Setting up” ⇨

Setting Up

The digitizer must be placed on a counter or tabletop.

SAFETY WARNING
Never place the digitizer on the floor.

Do not place digitizer on floor!

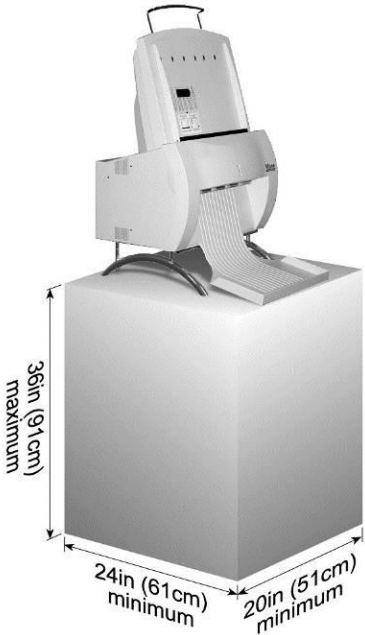

1. Identify Important Features

Look over the digitizer base and locate the features shown in this section. You will need to know where these features are when you assemble the digitizer.

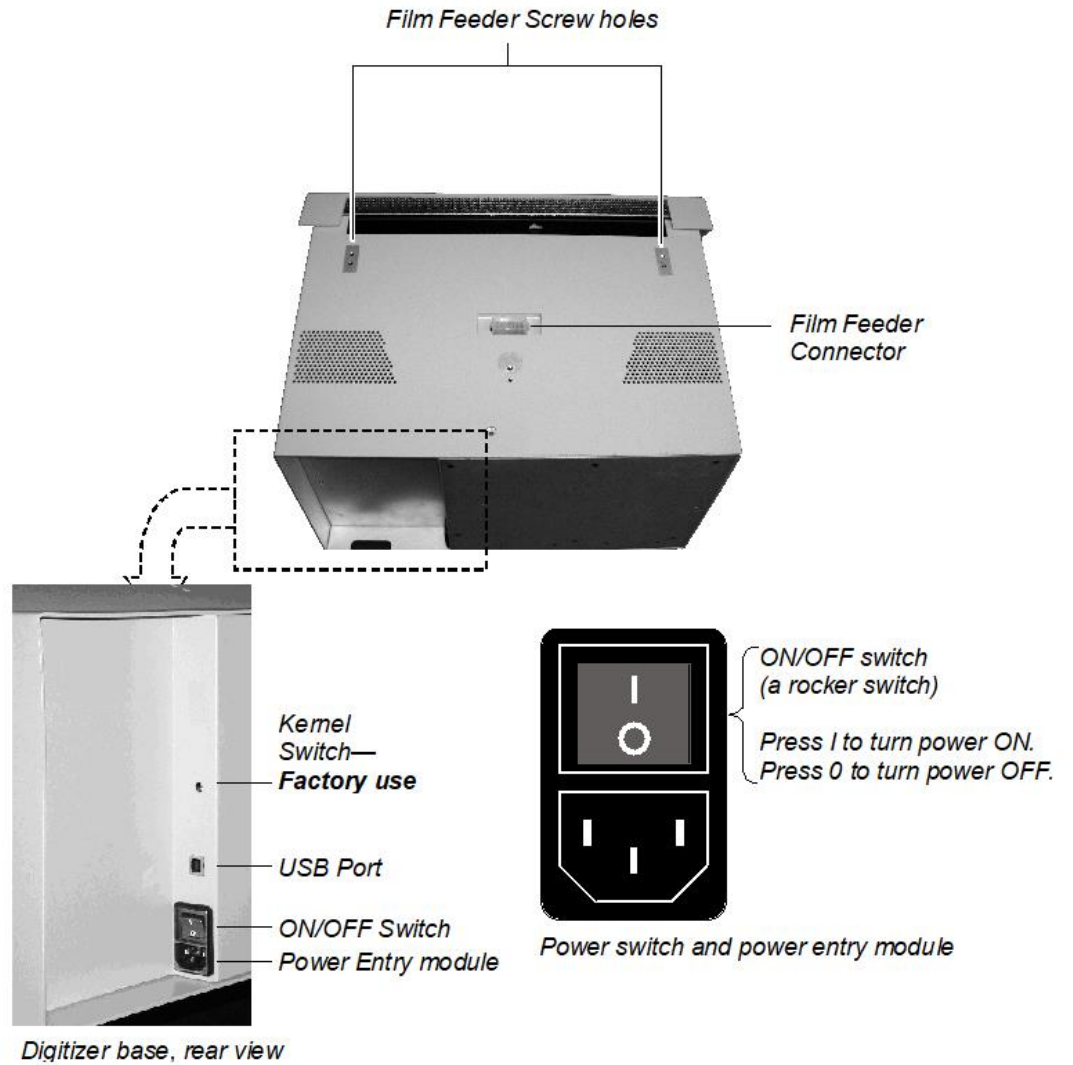

2. Assemble the Digitizer

1. Place the stand on a solid, flat surface (such as a table).
2. Place the digitizer base on the stand as shown below. Tighten the thumbscrews on the bottom of the stand to secure it to the digitizer.

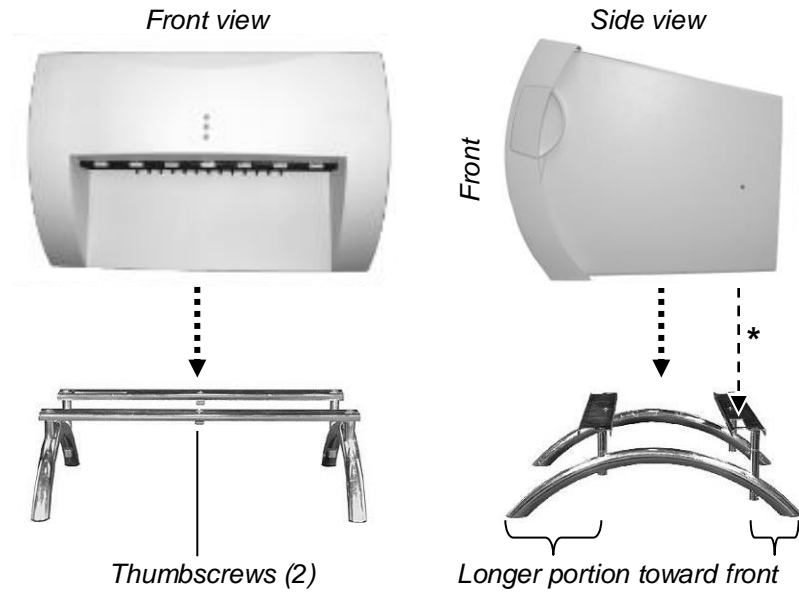

3. Attach the feeder to the digitizer:

- a. Note the three screws protruding from the bottom of the feeder. These mate to holes in the digitizer base. Two of the screws are very long—their top ends are near the top of the feeder.

Also note the connector on the bottom of the feeder. It mates to the connector on top of the digitizer base.

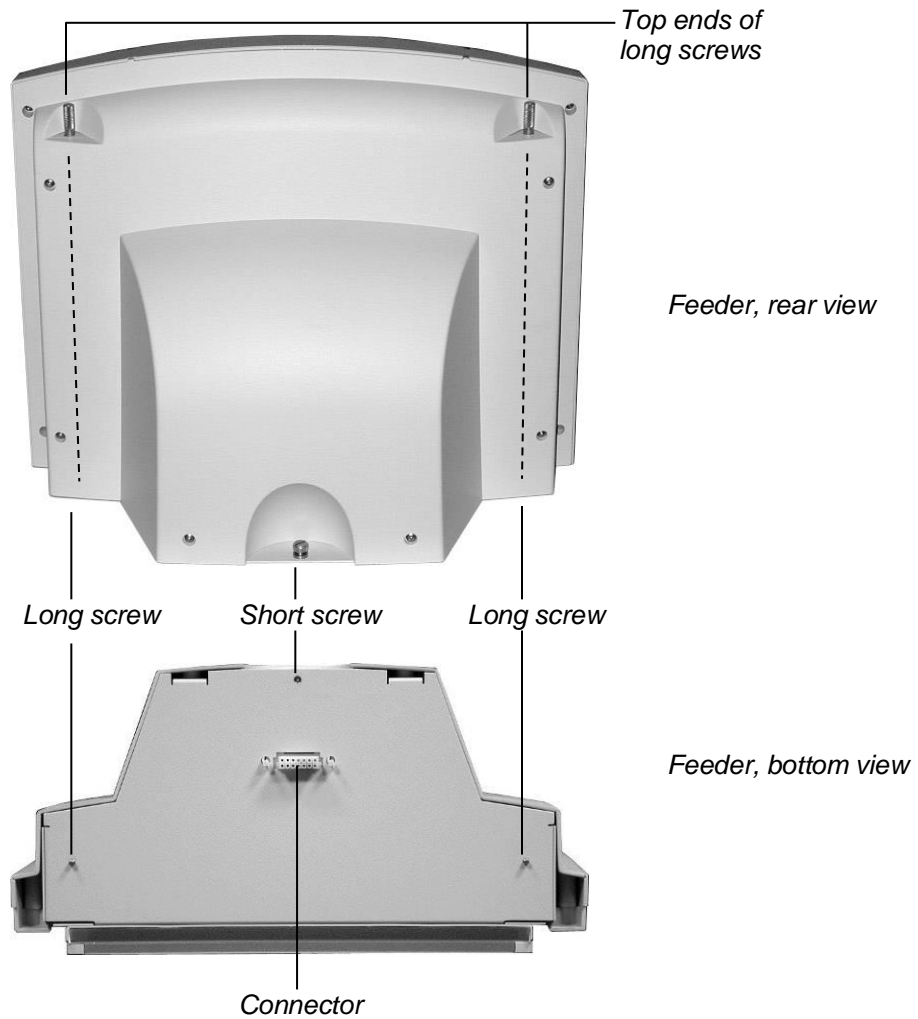

- b. Place the feeder on top of the digitizer, and slide the feeder connector into the digitizer connector.



- c. On the rear of the feeder, tighten the three screws to secure the feeder to the digitizer base.

Screws

- You may need to move the feeder slightly to get the screws started in the holes.
- Tighten each screw a few turns, then repeat until all are finger tight.

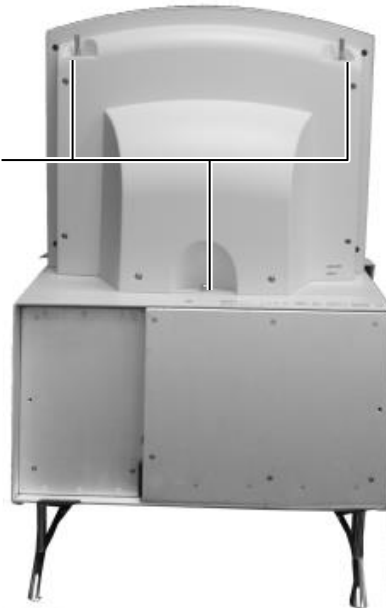

4. Install the exit tray by hooking it over the notched plastic edge just below the rollers. When the exit tray is properly positioned, it will be parallel to the roller shaft.

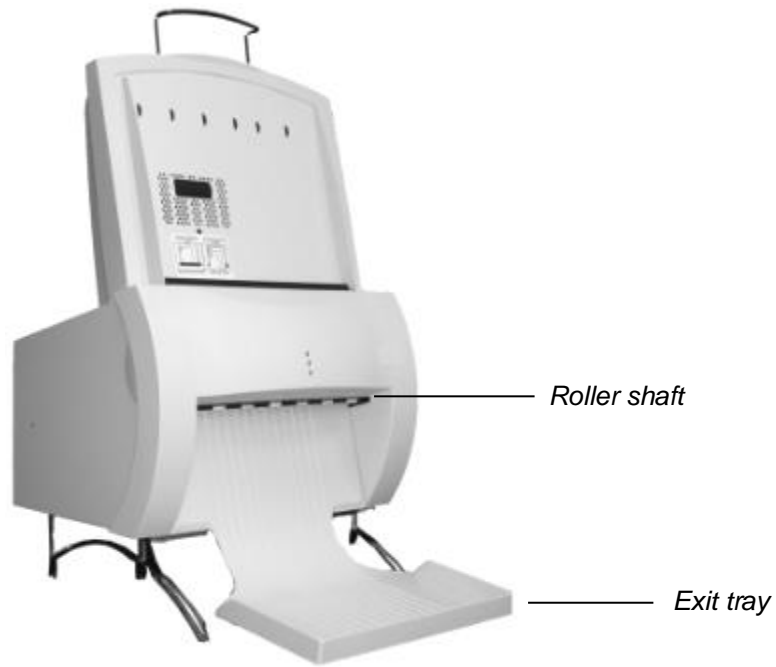

Properly installed exit tray

5. Insert the film support bar legs into the two holes on the film feeder's top edge. The film support bar's curved center portion must face the front of the film feeder.

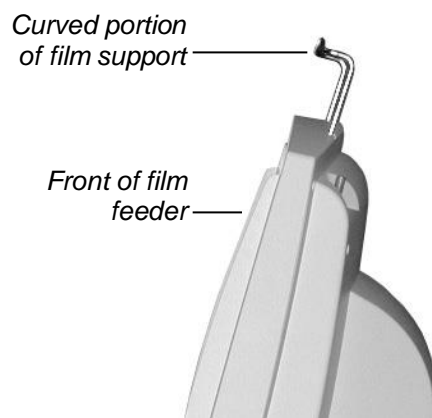
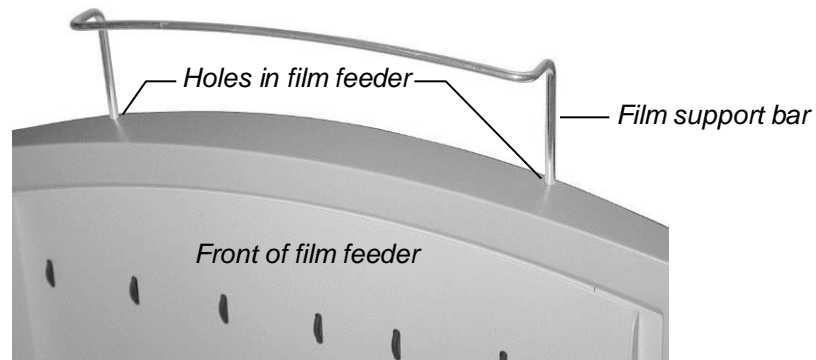

IMPORTANT: Do not lift or carry the digitizer using the film support bar.

Warning

Before you begin the installation procedure, turn off all power to the computer and peripherals.

Précaution

Avant de commencer la connexion, assurez vous que votre ordinateur soit bien éteint.

Advertencia

Antes de continuar con la instalación, favor de apagar su computadora y periférico.

Warnung

Vor dem Installieren den Computer und angeschlossene Geräte ausschalten.

3. Connect the Power Cord

1. Connect the power cord to the digitizer's Power Entry Module (PEM), located on the rear of the digitizer.



2. Connect the other end of the power cord to a grounded power outlet.

Note: The film digitizer has an auto-sensing power supply. When you apply power, the digitizer will detect the voltage and set itself for proper operation.

NEXT: “Device Driver Installation” ➡

Device Driver Installation

Install Device Drivers for Windows 7, 8, and 10

The USB driver is required for all installations to assure that the computer communicates with the digitizer.

1. Apply Power to the Digitizer

- a. Ensure the PC is turned **off**.

Note: Always turn on the digitizer before turning on the computer. This enables the computer to recognize the digitizer.

- b. Turn on the digitizer. The on/off switch is located on the back of the digitizer.



ON/OFF Switch
Power Entry module

Digitizer base, rear view

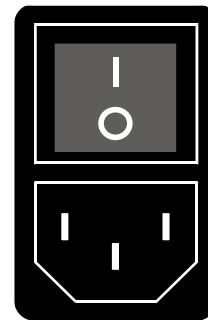

ON/OFF switch
(a rocker switch)
Press 1 to turn power ON.
Press 0 to turn power OFF.

Power switch and power entry module

- c. Wait for all three LEDs on the front of the digitizer to turn green.

2. About the VSCAN Drivers

The VSCAN driver is designed to provide compatibility between VSCAN *NDTPRO* Digitizers and Windows 7, 8, & 10. Features of this driver include:

- Installation/setup wizard for easy and consistent installation.

3. Install the VSCAN Drivers

Note: The computer must be running Windows 7, 8, & 10 Professional 32-bit or 64-bit.

Note: These instructions have been successfully tested on a wide range of Windows 7, 8, & 10 systems. In rare instances, you may have difficulty installing the VSCAN driver. If that happens, try again after logging on as Administrator, or as a user with Administrator rights.

You will need the **VSCAN *NDTPRO* Industrial Film Digitizer CD**.

- a. Be sure the digitizer is turned ON and all three LEDs are green, but that it is NOT connected to the PC. Wait until you are prompted to connect the digitizer to the PC.
- b. Turn on the PC.
- c. Insert the **VSCAN *NDTPRO* Industrial Film Digitizer CD** into the CD-ROM drive. Browse to the CD and double-click on *NDTPRO_Driver_6.1.exe* on the CD to install the driver.

d. In the first screen, click **Next >**.

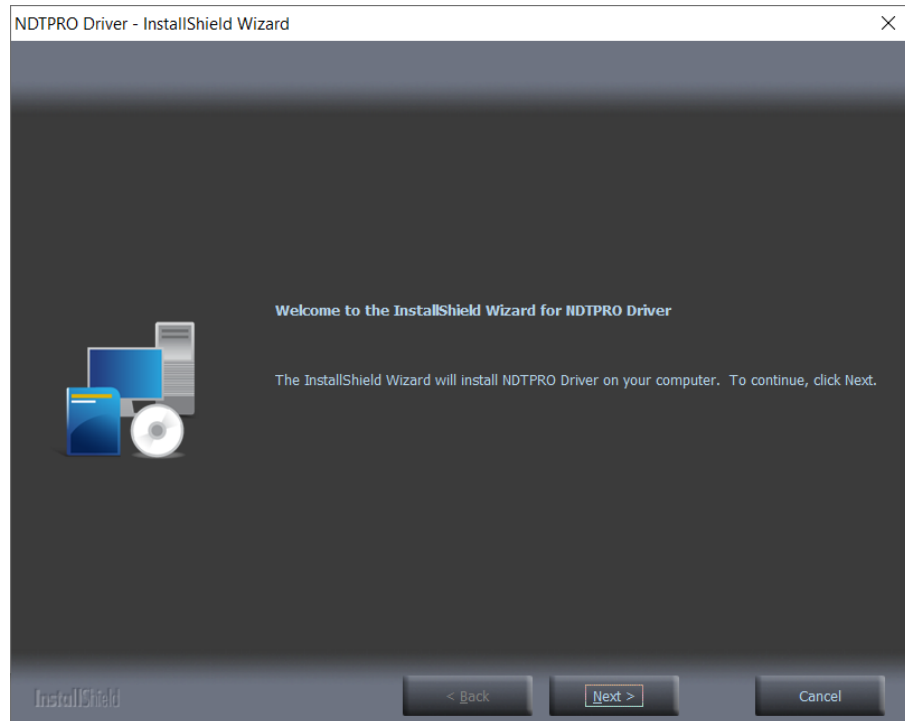

e. In the **Ready to Install the Program** screen, click **Install**.

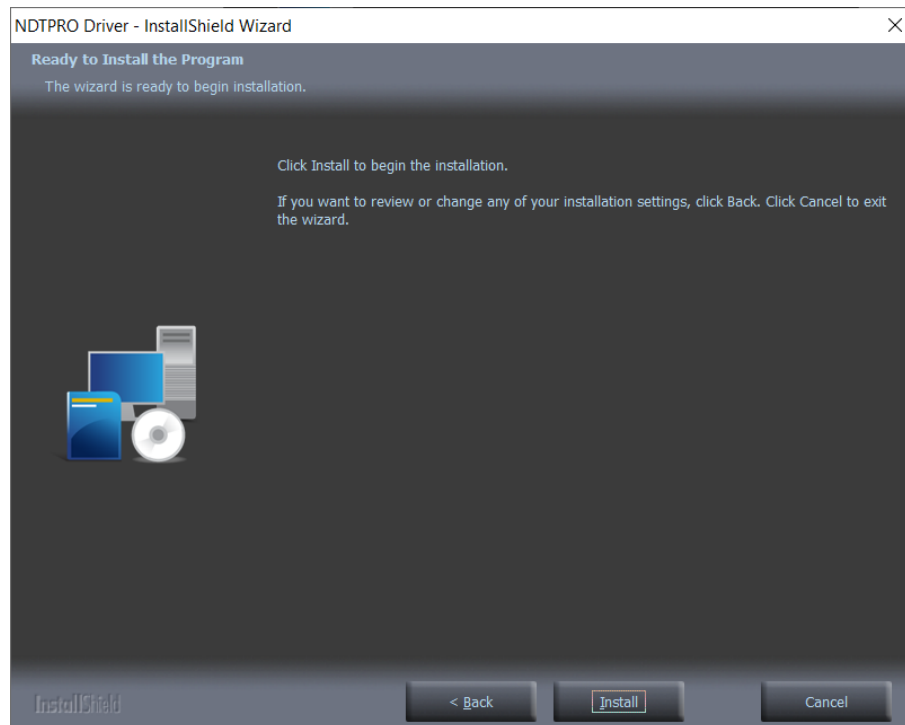

f. The **Setup Status** screen will appear. Wait while the files are installed.

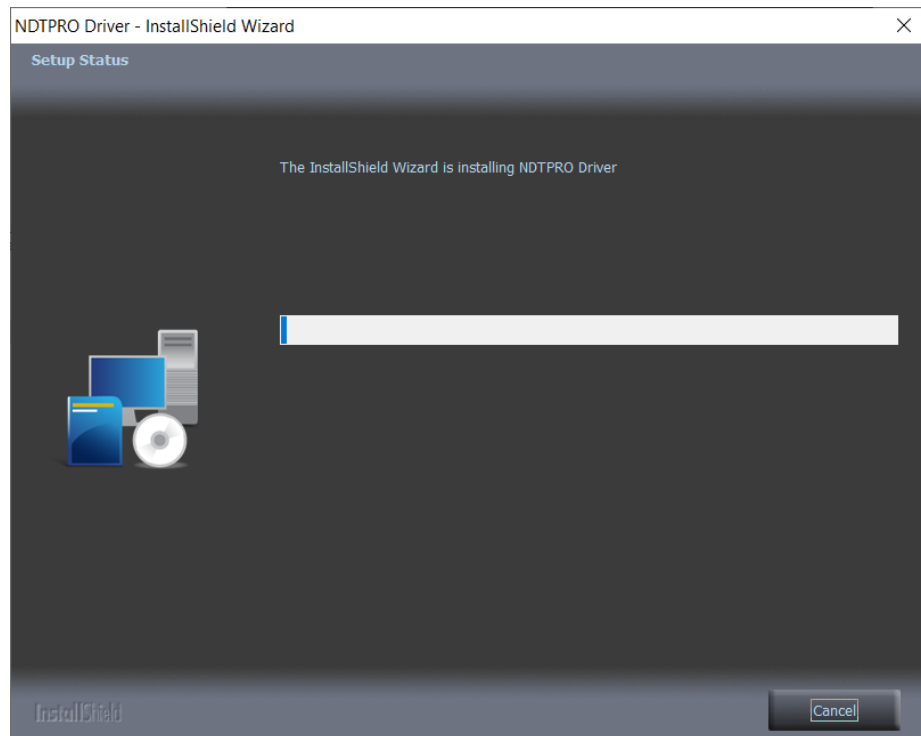

- g. When prompted “**Would you like to install this device software?**” Click **Install**.

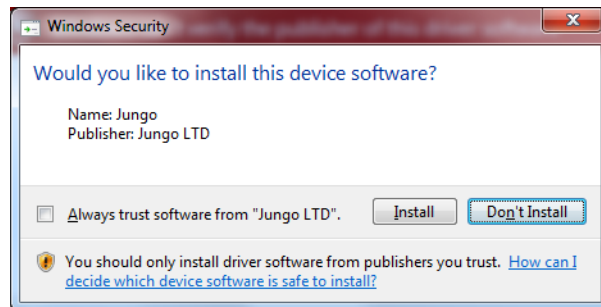

- h. InstallShield will indicate that installation is complete. However, the driver installation is not complete.

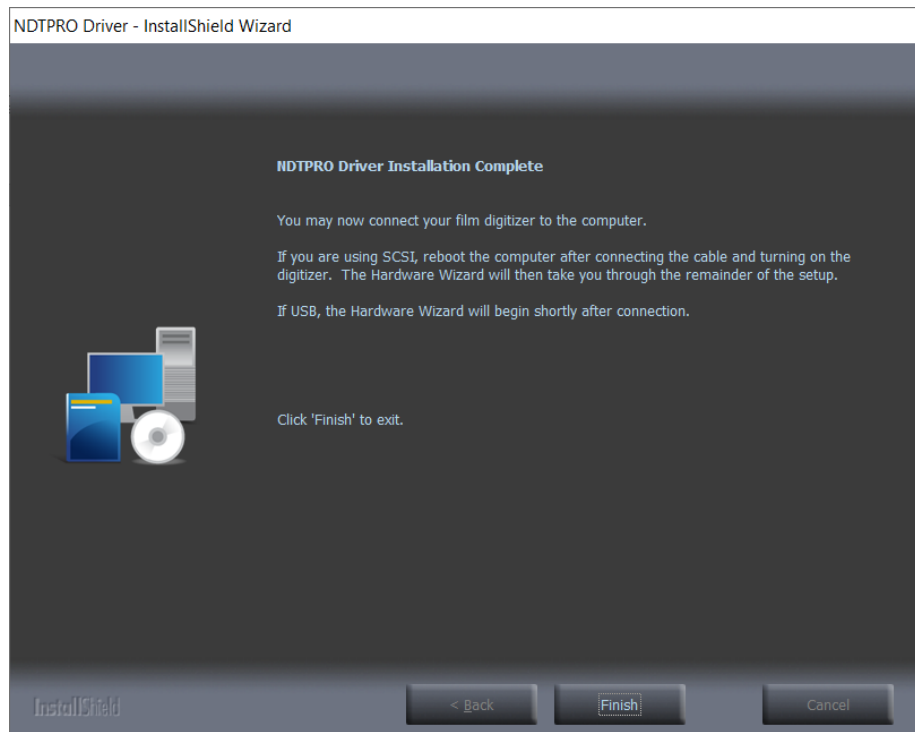

- i. Earlier, you connected a USB cable to the digitizer. Now, attach the connector on the other end of that cable to a USB 2.0 or 3.0 port on the computer.

Note: Wait 30 seconds after you connect the digitizer before you launch the NDTPROInfo program. This ensures the computer has recognized the new hardware and has installed the driver properly.

- j. On the desktop, double-click the **NDTPROInfo** icon.

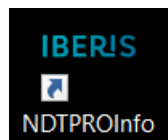

- k. A window will appear. If it shows “Communication established” then the digitizer is communicating with the computer.

Appendix:

Electromagnetic Guidance

Caution: Medical electrical equipment.
EMC (Electro Magnetic Compatibility) must be considered before any medical electrical equipment is installed or put into service. Follow the information in the accompanying documentation when installing and operating the VSCAN Digitizer.

Caution: Portable or mobile RF communication equipment can effect Medical Electrical equipment.

Caution: Using the Digitizer adjacent to or stacked with other equipment may cause interference between the equipment. Before utilizing stacked or adjacent equipment, verify proper functionality of all equipment in the actual configuration in which it will operate.

Caution: Connecting the Digitizer to equipment that is not rated CISPR 11 class A or class B may alter the electromagnetic characteristics.

Caution: In a domestic environment this product may cause radio interference in which case the user may be required to take adequate measures.

Guidance and manufacturer's declaration – electromagnetic equipment

Emissions test	Compliance	Electromagnetic environment - guidance
RF Emissions	Group 1	The Digitizers use RF energy only for their internal functions. Therefore, its RF emissions are very low and are not likely to cause any interference in nearby electronic equipment.
CISPR11	Class A	The Digitizers are suitable for use in all establishments other than domestic and those directly connected to the public low voltage power supply network that supplies buildings used for domestic purposes.

Guidance And Manufacturer's Declaration – Electromagnetic Immunity Enclosure Port

The VSCAN NDTPRO Industrial Film Digitizer is intended for use in the electromagnetic environment specified below. The customer or end user of the Digitizer should assure that it is used in such an environment.

Immunity test	Test method	Immunity Test Levels Professional healthcare facility environment
Electrostatic Discharge (ESD)	IEC 61000-4-2	± 8 kV contact ± 2 kV, ±4 kV, ± 8 kV, ± 15 kV air
Radiated RF EM fields	IEC 61000-4-3	3 V/m 80 MHz – 2,7 GHz 80% AM at 1 kHz
Proximity fields from RF wireless communications equipment	IEC 61000-4-3	See Table A
Rated power frequency magnetic fields	IEC 61000-4-8	30 A/m 50 or 60 Hz

Guidance And Manufacturer's Declaration – Electromagnetic Immunity - Input a.c. power

The VSCAN NDTPRO Industrial Film Digitizer is intended for use in the electromagnetic environment specified below. The customer or end user of the Digitizer should assure that it is used in such an environment.

Immunity test	Test method	Immunity Test Levels Professional healthcare facility environment
Electrical fast transient / bursts ^{a) l) o)}	IEC 61000-4-4	± 2 kV 100 kHz repetition frequency
Surges ^{a) b) j) o)} Line-to-line	IEC 61000-4-5	± 0,5 kV, ± 1 kV
Surges ^{a) b) j) k) o)} Line-to-ground	IEC 61000-4-5	± 0,5 kV, ± 1 kV, ±2 kV
Conducted disturbances induced by RF fields ^{c) d) o)}	IEC 61000-4-6	3 V ^{m)} 0,15 MHz – 80 MHz 6 V ^{m)} in ISM bands between 0,15 MHz and 80 MHz ⁿ⁾ 80 % AM at 1 kHz ^{e)}
Voltage dips ^{f) p) r)}	IEC 61000-4-11	0 % U_T ; 0,5 cycle ^{g)} At 0°, 45°, 90°, 135°, 180°, 225°, 270°, and 315° ^{q)}
		0 % U_T ; 1 cycle and 70 % U_T ; 25/30 cycles ^{h)} Single phase: at 0°
Voltage interruptions ^{f) i) o) r)}	IEC 61000-4-11	0 % U_T ; 250/300 cycle ^{h)}

Note: U_T is the A.C. mains voltage prior to application of the test level.

Guidance And Manufacturer's Declaration – Electromagnetic Immunity - Input a.c. power Continued:

- a) The test may be performed at any one power input voltage within the ME Equipment or ME SYSTEM RATED voltage range. If the ME EQUIPMENT or ME SYSTEM is tested at one power input voltage, it is not necessary to re-test at additional voltages.
- b) All the ME EQUIPMENT and ME SYSTEM cables are attached during the test.
- c) Calibration for current injection clamps shall be performed in a 150 Ω system.
- d) If the frequency stepping skips over an ISM or amateur band, as applicable, an additional test frequency shall be used in the ISM or amateur radio band. This applies to each ISM and amateur radio band within the specified frequency range.
- e) Testing may be performed at other modulation frequencies identified by the RISK MANAGEMENT PROCESS.
- f) ME EQUIPMENT and ME SYSTEMS with a d.c. power input intended for use with a.c. - to - d.c. converters shall be tested using a converter that meets the specifications of the MANUFACTURER of the ME EQUIPMENT or ME SYSTEM. THE IMMUNITY TEST LEVELS are applied to the a.c. power input of the converter.
- g) Applicable only to ME EQUIPMENT and ME SYSTEMS connected to single-phase a.c. mains.
- h) E.g. 10/12 means 10 periods at 50 Hz or 12 periods at 60 Hz.
- i) ME EQUIPMENT and ME SYSTEMS with RATED input current greater than 16 A / phase shall be interrupted one for 250/300 cycles at any angle and at all phases at the same time (if applicable). ME EQUIPMENT and ME SYSTEMS with battery backup shall resume line power operation after the test. For ME EQUIPMENT and ME SYSTEMS with RATED input current not exceeding 16 A, all phases shall be interrupted simultaneously.
- j) ME EQUIPMENT and ME SYSTEMS that do not have a surge protection device in the primary power circuit may be tested only at ± 2 kV line(s) to earth and ± 1 kV line(s) to line(s).
- k) Not applicable to CLASS II ME EQUIPMENT and ME SYSTEMS.
- l) Direct coupling shall be used.
- m) r.m.s., before modulation is applied.
- n) The ISM (industrial, scientific and medical) bands between 0,15 MHz and 80 MHz are 6,765 MHz to 6,795 MHz; 13,553 MHz to 13,567 MHz; 26,957 MHz to 27,283 MHz; and 40,66 MHz to 40,70 MHz. The amateur radio bands between 0,15 MHz and 80 MHz are 1,8 to 2,0 MHz, 3,5 MHz to 4,0 MHz, 5,3 MHz to 5,4 MHz, 7 MHz to 7,3 MHz, 10,1 MHz to 10,15 MHz, 14 MHz to 14,2 MHz, 18,07 MHz to 18,17 MHz, 21,0 MHz to 21,4 MHz, 24,89 MHz to 24,99 MHz, 28,0 MHz to 29,7 MHz and 50,0 MHz to 54,0 MHz.
- o) Applicable to ME EQUIPMENT and ME SYSTEMS with RATED input current less than or equal to 16 A / phase and ME EQUIPMENT and ME SYSTEMS with RATED input current greater than 16 A / phase.
- p) Applicable to ME EQUIPMENT and ME SYSTEMS with RATED input current less than or equal to 16 A / phase.
- q) At some phase angles, applying this test to ME EQUIPMENT with transformer mains power input might cause an overcurrent protection device to open. This can occur due to magnetic flux saturation of the transformer core after the voltage dip. If this occurs, the ME EQUIPMENT or ME SYSTEM shall provide BASIC SAFETY during and after the test.
- r) For ME EQUIPMENT and ME SYSTEMS that have multiple voltage settings or auto ranging voltage capability, the test shall be performed at the minimum and maximum RATED input voltage. ME EQUIPMENT and ME SYSTEMS with a RATED input voltage range of less than 25 % of the highest RATED input voltage shall be tested at one RATED input voltage within the range.

Immunity to proximity fields from RF wireless communications equipment

The ENCLOSURE PORT of ME EQUIPMENT and ME SYSTEMS shall be tested as specified in Table A using the test methods specified in IEC 61000-4-3.

The frequencies and services listed in Table A are representative examples that are based on RF communications equipment in use at the time of publication of this collateral standard. The test specification does not attempt to cover every frequency and service used in every country. The RISK MANAGEMENT PROCESS should take current communications services into account. Testing should be performed at the additional frequencies identified that are not represented in Table A.

While communication might not be possible when ME EQUIPMENT that includes radio equipment is tested in its bandwidth, the ME EQUIPMENT or ME SYSTEM shall still be able to provide its BASIC SAFETY and ESSENTIAL PERFORMANCE.

Table A- Test specifications for Enclosure Port immunity to RF wireless communications equipment.

The customer or the user of the VSCAN NDTPRO Industrial Film Digitizer can help prevent electromagnetic interference by maintaining a minimum distance between portable and mobile RF communications equipment (transmitters) and the Digitizer as recommended below, according to the maximum output power of the communications equipment.

Test frequency (MHz)	Modulation ^{a)}	Maximum power (W)	Distance (m)	Immunity Test Level (V/m)
385	Pulse modulation 18 Hz	1,8	0,3	27
450	FM ^{b)} ±5 kHz deviation 1 kHz sine	2	0,3	28
710	Pulse modulation 217 Hz	0,2	0,3	9
745				
780				
810	Pulse modulation 18 Hz	2	0,3	28
870				
930				
1 720	Pulse modulation 217 Hz	2	0,3	28
1 845				
1 970				
2 450	Pulse modulation 217 Hz	2	0,3	28
5 240	Pulse modulation 217 Hz	0,2	0,3	9
5 500				
5 785				

NOTE: If necessary to achieve the Immunity Test Level, the distance between the transmitting antenna and the ME Equipment or ME System may be reduced to 1 m. The 1 m test distance is permitted by IEC 61000-4-3

- a) The carrier shall be modulated using a 50% duty cycle square wave signal.
- b) As an alternate to FM modulation, 50% pulse modulation at 18 Hz may be used because while it does not represent actual modulation, it would be worst case.

The Manufacturer should consider reducing the minimum separation distance, based on RISK MANAGEMENT, and using higher IMMUNITY TEST LEVELS that are appropriate for the reduced minimum separation distance. Minimum separation distances for higher IMMUNITY TEST LEVELS shall be calculated using the following equation:





$$E = \frac{6}{d} \sqrt{P}$$

Where *P* is the maximum power in W, *d* is the minimum separation distance in m, and *E* is the IMMUNITY TEST LEVEL in V/m.

If the ME EQUIPMENT or ME SYSTEM complies with the higher IMMUNITY TEST LEVELS for this test, the 30 cm minimum separation distance (per above table) may be replaced with minimum separation distances calculated from the higher IMMUNITY TEST LEVELS.

Appendix:

Symbols

Symbol	Description
	Indicates the need for the user to consult the instructions for use for important cautionary information such as warnings and precautions that cannot, for a variety of reasons, be presented on the device itself.
	Indicates the need for the user to consult the instructions for use.
	Compliance to EU Directives
	This symbol on the product indicates that this product must not be disposed of as unsorted municipal waste. Instead it is your responsibility to dispose of your waste equipment by handing it over to a designated collection point for recycling of waste electrical and electronic equipment. For more information about where you can dispose of your waste equipment for recycling please contact your local city office, your household waste disposal service or the shop where you purchased the product.
	This symbol on the product indicates that this product does not use certain hazardous substances.



IBERIS

S O F T W A R E

**Av. Flórez Estrada, 9,
office 1A**

Phone:

Web:

Email:

**33180 Noreña, Asturias,
Spain**

+34 984 030 851

www.iberisoft.com

support@iberisoft.com