



VSCAN NDT*PRO* **Industrial Film Digitizer**

User Guide

(Serial Numbers 371,000 to 379,999)



Iberis Software S.L.
Av. Flórez Estrada, 9, office 1A
33180 Noreña, Asturias, Spain

Phone: +34 984 030 851
Internet: www.iberisoft.com

Technical Support:
E-mail: support@iberisoft.com

Caution: No operator-serviceable parts inside. Refer servicing to qualified personnel.

Achtung: Gehäuse nicht öffnen. Wartung und Reparatur nur durch Elektrofachkräfte.

Attention: Aucune pièce ne peut être remplacée par l'utilisateur. Toute opération de maintenance doit être effectuée par une personne qualifiée.

Atencion: Acceso interno solo autorizado a personal técnico cualificado.

Attenzione: Non aprire. Rivolgersi a personale qualificato.

Radio Frequency Emissions

This equipment has been tested and found to comply with the limits for a Class A digital device, pursuant to Part 15 of the FCC Rules. These limits are designed to provide reasonable protection against harmful interference when the equipment is operated in a commercial environment. This equipment generates, uses, and can radiate radio frequency energy and, if not installed and used in accordance with the instruction manual, may cause harmful interference to radio communications. Operation of this equipment in a residential area can cause harmful interference, in which case the user will be required to correct the interference at his or her own expense.

Product compliance testing was conducted using VSCAN shielded cables. Modifications to the digitizer or the VSCAN shielded cables or the use of cables other than those available from VSCAN could void the user's authority to operate the equipment.

Acceptable shipping conditions

- Temperature: -18° to $+60^{\circ}\text{C}$ (0° to $+140^{\circ}\text{F}$)
- Relative humidity: 20% to 85%, non-condensing
- Atmospheric pressure: 500 to 1060hPa (+18,000 to -1,200ft)

Operating conditions

- Temperature: 10°C to 30°C (60°F to 85°F)
- Relative humidity: 20% to 85%, non-condensing
- Atmospheric pressure: 696 to 1013hPa (10,000 to 0 ft)

Electrical supply

- Voltage: 100 to 240 VAC
- Current: 0.75 to 1.5 A
- Frequency: 47 to 63 Hz

Safety and compliance information



Accessory equipment connected to the analog and digital interfaces must be certified according to the respective IEC standards (i.e. IEC 60950 for data processing equipment).

This product is rated for continuous use.

This product is in the Ordinary Equipment Class. It provides no protection against the ingress of water.

This product is not suitable for use in the presence of flammable anesthetic mixtures with air or with oxygen or with nitrous oxide.

WARNING: To avoid the risk of electric shock, this equipment must only be connected to a supply mains with protective earth.

WARNING: Do not modify this equipment without authorization of the manufacturer.

Do not position the product so that it is difficult to access the disconnect switch (power switch) on the back of the unit.

Mains power may be removed from the product by turning off the power switch on the back of the unit.

Power cords used with this device in North America must be rated by Underwriters Laboratories for hospital use.

Power cords used with this device in Europe must meet the requirements of IEC 227 Designation 53 or IEC 245 Designation 53.

Correct and safe operation of the digitizer requires familiarity with information that is not marked on the product. The following symbols indicate that the operator should consult the manual for additional information:



This Class 1 LED device is safe under reasonably foreseeable conditions of operation.

The LED illumination system consists of 16 Class 1 LEDs, a mirror system to spread the light, and a diffuser to distribute the light approximately uniformly across an area of 2.4 sq. in (15.5 sq. cm). Light from the LED illuminator may be indirectly observed in the digitizer's film entry and exit areas.

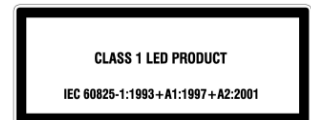

Contents

- Intended Use.....6**
- Operating7**
- VSCAN NDT*PRO* Industrial Film Digitizer7**
 - About Digitizer and Film Sizes 7
 - About Films..... 8
 - Basic Operating Instructions..... 8
 - Digitizing a Single Film 10
 - Digitizing Multiple Films 12
- Preventive Maintenance.....14**
 - Cleaning the Auto-Feed Roller..... 14
 - Cleaning the Diffuser..... 15
 - Replacing the Lamp Cartridge 19
- Troubleshooting.....20**
 - Reading the LEDs 20
 - Top LED: feeder status 21
 - Center LED: Digitizer Status..... 21
 - Bottom LED: Power Status..... 22
 - In Case of Difficulty 22
- Weights and Dimensions24**
 - Shipping weight and dimensions 24
 - Digitizer weight and dimensions: 24
- Packing the Film Digitizer for Shipment.....25**
 - 1. Turn Off the Digitizer 25
 - 2. Disconnect the Power Cord and USB Cable 25
 - 3. Remove the Exit Tray from the Digitizer Base 26
 - 4. Remove the Feeder from the Digitizer Base..... 27
 - 5. Remove the Digitizer Base from the Stand..... 28
 - 6. Wrap Certain Items..... 28
 - 7. Pack the Accessory Box 29
 - 8. Pack the Shipping Carton 31
- Appendix: Electromagnetic Guidance32**
- Appendix: Symbols36**

Intended Use

The *NDTPRO* Industrial Film Digitizer is intended for making digital copies of x-ray films for non-destructive testing applications. This device is not intended for medical use.

Operating

VSCAN NDT^{PRO} Industrial Film Digitizer

About Digitizer and Film Sizes

Nominal resolution	Pixels (14"x17" film)	Spot size (µm)	DPI	Line pairs per mm
2K x 2.5K	2100 x 2550	170	150	3
4K x 5K	4200 x 5100	85	300	6
8K x 10K	7980 x 9690	44	570	11

Scan modes 16-bit, 12-bit and 8-bit grayscale outputs

Manual Feed

Film sizes Width: 2.36" to 14" (6cm to 35.6cm)
Length: 8" to 200"† (20.3cm to 5080cm)
Thickness: 0.006" to 0.010" (0.15mm to 0.51mm)

† Longer films over 17" require user support during feeding, and a scanning application that handles long films.

Auto film feeder Standard 25-film capacity (mixed sizes, no presorting)

Film sizes "Light box loading": head-up, normal reading, left justified
Width: 7" to 14" (20.3cm x 35.6cm)
Length: 8" to 17" (20.3cm x 43.2cm)
Thickness: 0.006" to 0.010" (0.15mm to 0.51mm)

About Films

The film digitizer handles standard radiograph film sizes up to 14” (35.5cm) wide.

You can batch feed multiple films (up to 25), and you can mix film sizes ranging from 8” x 8” (20.3cm x 24.5cm) to 14” x 17” (35.5cm x 43cm) in one batch feed stack—as long as you follow the rules below.

IMPORTANT: Remove stickers, tape, staples, paper clips, etc. from films before scanning. These may cause serious film feeding problems and may damage the digitizer’s internal mechanisms. **Failure to remove extraneous items from films will void your warranty.**

Load films just as you would view them on a light box, with these qualifications:

- Films must be loaded left justified.
- Do not load films more than 17” (43.2cm) long for batch scanning in the auto feeder. See “Digitizing a single film,” later in this chapter, when loading films longer than 17”.
- If loading films with a curl, best practice is to load the film with the curl facing front as indicated by the image below and by the label found on the front of the scanner’s feeder.

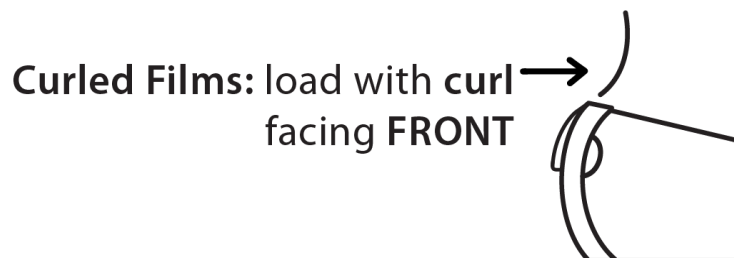

Basic Operating Instructions

1. Turn on the film digitizer and wait for all three LEDs to turn green.

Note: Always turn on the film digitizer before turning on the computer. This enables the computer to recognize the digitizer.

Note: Several minutes are required for the digitizer to carry out its internal diagnostics and establish communications with the scanning application. These activities must be completed before you can load film into the digitizer.

2. Turn on the computer.
3. Launch the scanning application.

IMPORTANT: Remove stickers, tape, staples, paper clips, etc. from films before scanning. These may cause serious film feeding problems. Failure to remove extraneous items from films will void your warranty.

4. If you will be digitizing films 17” (43.2cm) or longer, raise the film support bar.

- Longer films out to 200” may require manual support.

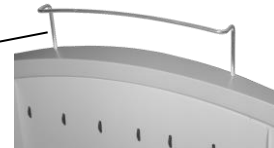

5. Load the film.

How you load the film depends on whether you are digitizing one film or multiple films, and the film sizes to be digitized. See the next pages for details.

CAUTION: X-ray images displayed on a computer monitor are representative only. A variety of factors influence image density and size—including monitor luminance and calibration, window and level settings, zoom level, and dimensional and grayscale inaccuracies resulting from build-up of tolerances in the digitizer, display board and computer. For this reason, special precautions must be exercised (e.g., calibrating the software ruler and computer monitor) when taking measurements from digitized images. Please refer to the user’s manual for your digitizing software for more information.

Note: All films, regardless of size, must be left justified when loaded into the feeder and/or digitizer.

Digitizing a Single Film

Options for digitizing single films

There are two ways to scan a single film:

- By manually inserting the film behind the blue bar (as described in this section), or
- By treating the single film as a batch-of-one (if the scanning application supports this approach); for instructions, see “Digitizing multiple films” (next section in this manual).

The digitizer *cannot batch-of-one feed* a single film smaller than 2.36" wide x 8" long (5.99cm wide x 20.3cm long). **Do not scan paper.**

1. Hold the film in front of you as you would view it on a light box.
2. Align the **left edge** of the film with the film guide on the **left side** of the feeder.
3. Place the film into the slot **BEHIND the blue bar**.

The blue bar has a lip and a groove on the top edge of the digitizer where the feeder is attached. Place a single film directly behind the blue bar.



When the digitizer senses the film, it automatically stages the film in preparation for digitizing. The film will first move down, then up. This is normal operation.

CAUTION: If the film is not staged properly, do not manually pull the film out of the digitizer. Instead, use the scanning application’s EJECT command to remove the film.

Note: When a film has been staged, it is in the digitizer’s light path. The ADC (Automatic Digitizer Calibration) feature requires that the light path be clear of the film for proper background calibration of the digitizer. The digitizer will automatically adjust the film’s position to properly proceed with ADC. Depending on the location of the film’s leading or trailing edge, and the length of time the film has been blocking the light path, the film will be: a) pushed up, or b) pushed down.

4. Using your scanning software, execute the **Scan** command.

Note: Proper orientation of the film during loading depends on the scanning application program you are using. Some scanning programs rotate images 180° for display. If images appear upside down, you may be able to set the default orientation in the scanning application. If this option is not available, then insert films into the digitizer upside down, as shown here.

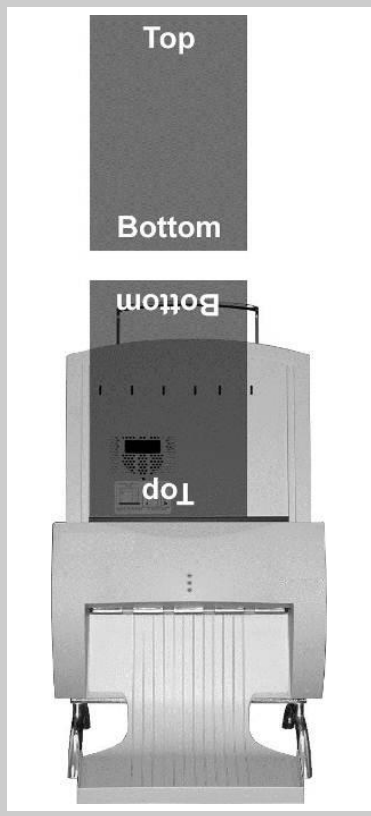

Digitizing Multiple Films

CAUTION: Do not load more than 25 films at one time.

1. Hold the film stack in front of you as you would view it on a light box.

Films at the back of the stack are digitized first.

Note: The digitizer cannot *batch feed* films smaller than 8" wide x 8" long (20.3cm wide x 20.3cm long). When loading small films, the vertical dimension *must* be at least 8" (20.3cm). **Do not scan paper.**

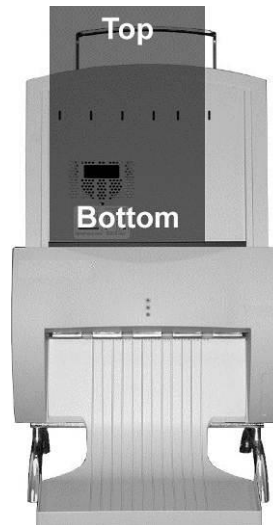

2. Align the left edge of the film stack with the film guide on the left edge of the feeder.
3. Place the film stack **IN the groove in the blue bar**.

The blue bar has a lip and a groove on the top edge of the digitizer where the feeder is attached.

Note: If you are digitizing a single film, place the film directly **BEHIND the blue bar**. (This film must be at least 8" wide x 8" long (20.3cm wide x 20.3cm long).

Note: When a film has been staged, it is in the digitizer's light path. The ADC (Automatic Digitizer Calibration) feature requires that the light path be clear of the film for proper background calibration of the digitizer. The digitizer will automatically adjust the film's position to properly proceed with ADC. Depending on the location of the film's leading or trailing edge, and the length of time the film has been blocking the light path, the film will be: a) pushed up, or b) pushed down.

4. Using your scanning software, execute the **Scan** command.

Note: During extended batch scans (more than 5 films), the digitizer may pause periodically to recalibrate. This is normal operation.

Preventive Maintenance

Cleaning the Auto-Feed Roller

After extensive use, dust or lint particles may build up on the Auto-Feed Roller. It is recommended to clean the roller at least twice per year.

Loop a piece of light adhesive tape (such as Scotch® Magic™ Tape) around your fingers with the adhesive side out, then gently pat the roller. Pat and turn the roller until its entire surface is clean.

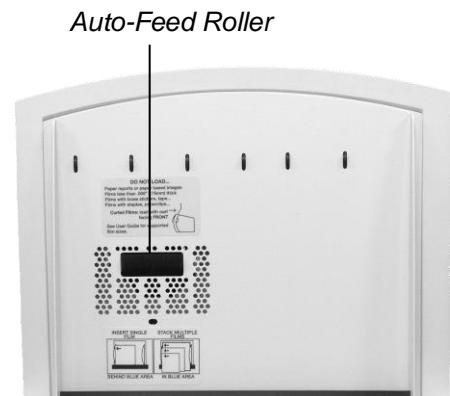

CAUTION:

- **Do not** use any type of cleaning solvent on the feed roller and idler wheels, as this could damage these components and cause improper operation.
- **Do not** use tape with a strong adhesive, such as packing tape or strapping tape.
- **Do not** use tape requiring the adhesive to be wetted, such as brown paper packing tape.

Cleaning the Diffuser

If you notice streaks (vertical artifacts) in images, you should clean the diffuser.

1. Turn off the digitizer. **Allow 10 to 15 minutes for the bulb cartridge to cool to a comfortable temperature before removing it.**
2. Open the door on the side of the digitizer base:
3. Remove the lamp Cartridge Clamp using a #2 Philips screwdriver.

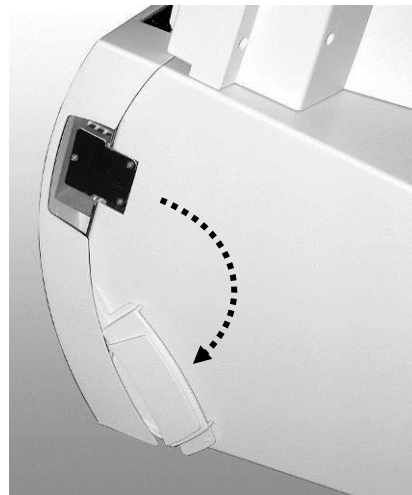
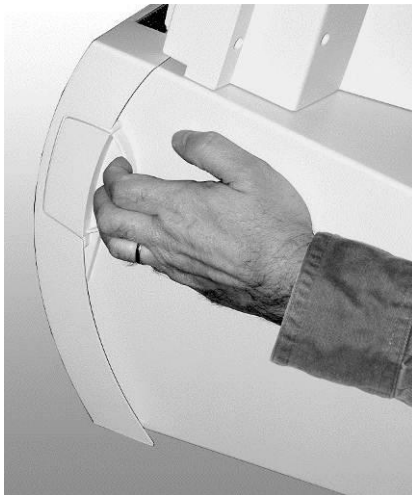

4. Grasp the top and bottom of the lamp cartridge, and then pull it out.

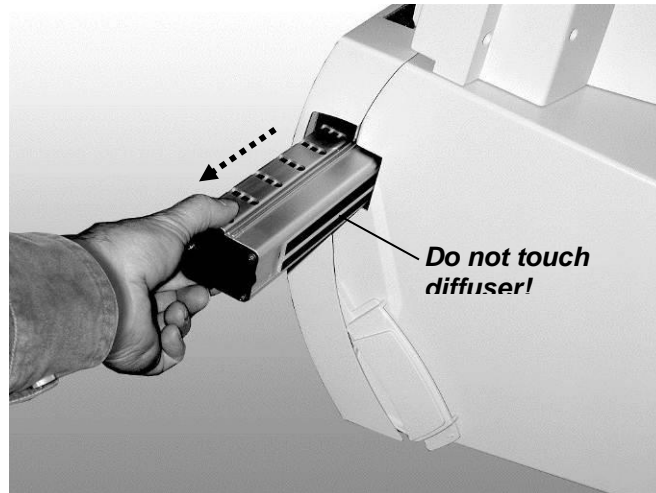

CAUTION: Do not touch the diffuser material with your fingers.

5. Place the lamp cartridge on a flat surface with the diffuser facing up.
6. Clean the diffuser using a lint-free wipe. **Wipe in one direction only. Do not wipe back and forth.**

Note: The lamp cartridge assembly will resemble the image shown below:

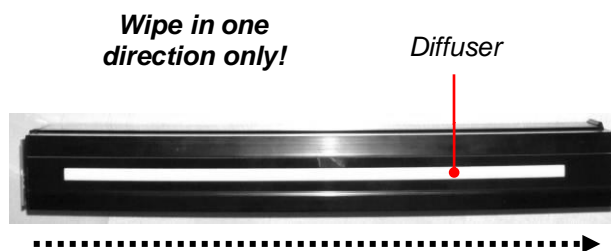

IMPORTANT: DO NOT USE ALCOHOL or other SOLVENTS as they may degrade the diffuser and void your warranty.

7. Insert the lamp cartridge into the digitizer base:

- The diffuser must face the rear of the digitizer base.
- The end of the lamp cartridge with the white connector goes in first.
- Ensure the slots along the top and bottom of the cartridge align with the slides in the digitizer (see illustration at right).
- When the cartridge is nearly all the way in, push it firmly until you feel the connector snap into place.

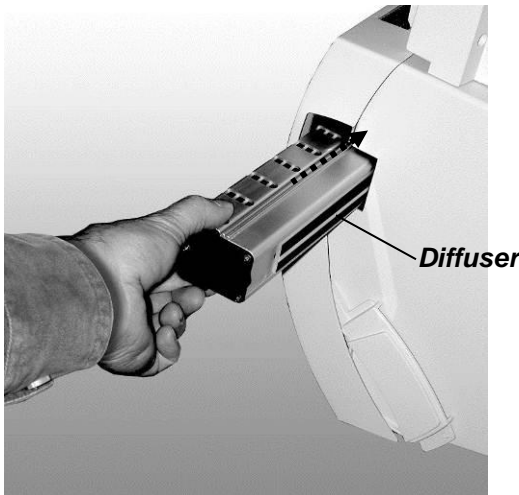
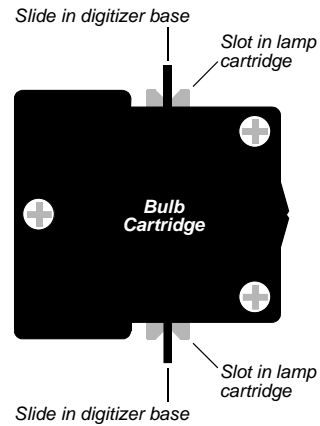

Slide cartridge in...

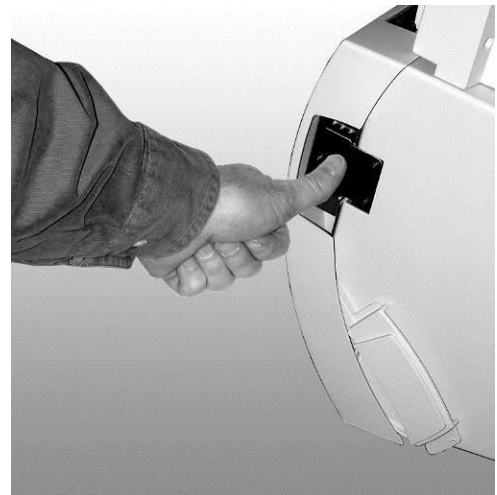

then push to seat connector

8. Re-install the lamp cartridge clamp assembly if removed earlier.



9. Close the door on the side of the digitizer base. Be sure the door closes fully.

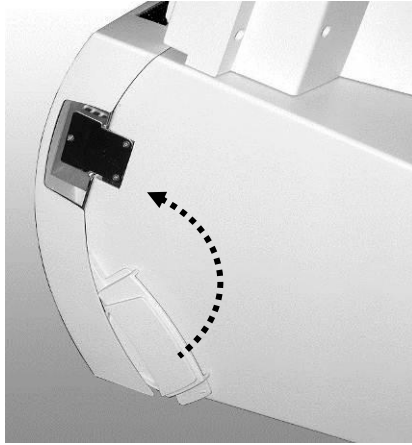

10. Turn on the digitizer. The digitizer will recalibrate to the cleaned diffuser.

Replacing the Lamp Cartridge

WARNING: The lamp cartridge assembly is specific to the **NDT*PRO* Industrial Film Digitizer** model. Ensure you have the correct replacement lamp Cartridge before installing a new lamp.

Contact VSCAN Technical Support if you have any questions about installing or using your VSCAN film digitizer:

Phone: +34 984 030 851

E-mail: support@iberisoft.com

Follow the instructions in “Cleaning the Diffuser,” earlier in this chapter, but work with the new lamp cartridge in steps 5 through 10.

Preventive maintenance is not covered under warranty. (Only failures during the published warranty period are covered by warranty replacement. Failures must be confirmed by running VSCAN’s Digitizer Diagnostic Tool. The software generates a report showing light values indicative of lamp performance. You can request a copy of the Digitizer Diagnostic program from VSCAN Technical Support.)

Troubleshooting

Reading the LEDs

Three LEDs on the front of the digitizer provide operating information.

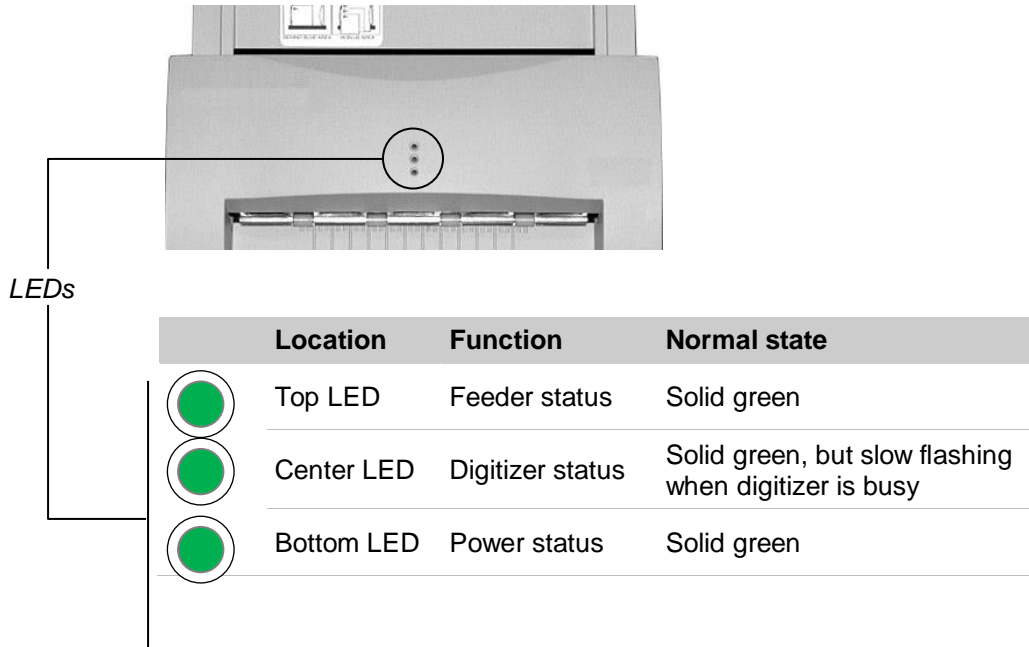

Tables on the next three pages explain all LED states.

Top LED: feeder status

LED state	Digitizer condition	Corrective action
Solid green	Ready	None. The feeder is ready to operate.
Off	ERROR: no feeder attached	<ol style="list-style-type: none">1. Turn off digitizer.2. Remove feeder.3. Inspect electrical connector and screws on bottom of feeder.
Fast flashing green	ERROR: unknown feeder attached	Check feeder: <ol style="list-style-type: none">1. Turn off digitizer.2. Remove feeder.3. Inspect electrical connector and screws on bottom of feeder.
Slow flashing green	BUSY: film is staging	None. This is normal operation.
Fast flashing green	ERROR: film staging problem	Eject film by clicking the eject button in the scanning application.

Center LED: Digitizer Status

LED state	Digitizer condition	Corrective action
Solid green	Ready	None. The digitizer is ready to accept commands from the scanning application.
Slow flashing green	BUSY: normalizing	None. This is normal operation. The LED will flash slowly during initial calibration after power is applied, and when the scanning application initiates a calibration.
Slow flashing green	BUSY: tracking (ADC)	None. This is normal operation. The LED will flash periodically when the digitizer is idle. Automatic Digitizer Calibration (ADC) is independent of the scanning application.
Slow flashing green	BUSY: staging film	None. This is normal operation. The LED will flash slowly while the digitizer is staging the film.
Slow flashing green	BUSY: Positioning film	None. This is normal operation. The LED will flash slowly while the scanning application is positioning the film.
Slow flashing green	BUSY: digitizing film	None. This is normal operation. The LED will flash slowly while a film is being digitized.
Slow flashing green	BUSY: ejecting film	None. This is normal operation. The LED will flash slowly while the scanning application is ejecting the film.
Off	ERROR	<ol style="list-style-type: none">1. Make certain power is supplied to the digitizer, and that the digitizer power switch is on.2. If problem persists, get qualified technical help (see “In case of difficulty,” later in this chapter).

Bottom LED: Power Status

LED state	Digitizer condition	Corrective action
Solid green	Ready	None.
Fast flashing green	ERROR: DSP not communicating	Get qualified technical help (see “In case of difficulty,” later in this chapter).
Fast flashing green	ERROR: unknown ballast	Get qualified technical help (see “In case of difficulty,” later in this chapter).
Off	ERROR	<ol style="list-style-type: none">1. Make certain power is supplied to the digitizer, and that the digitizer power switch is on.2. If problem persists, get qualified technical help (see “In case of difficulty,” later in this chapter).

In Case of Difficulty

How to use this section:

1. Look through the left columns to find a description of the problem you are having.
2. Follow the instructions (in order) in the “Corrective action” column. If the one corrective action does not solve the problem, then carry out the next corrective action.
3. When the instruction is “Get qualified technical help,” then:
 - a. Contact your system integration specialist (the company or person that installed your VSCAN film digitizer).
 - b. If your system integration specialist is not available, then contact VSCAN Customer Support (support@iberisoft.com). Please record system information and digitizer serial number before calling, and have it available when calling.

Tip: Check www.iberisoft.com for additional information, support, and updates.

Symptom	Corrective action
Cannot turn digitizer on or off. Cannot find power switch.	The on/off switch is located on the rear of the digitizer body. Look at the digitizer from the rear to see the switch.
Streaks in image	Clean lamp diffuser (see “Cleaning the diffuser” in the “Cleaning and maintaining” chapter, earlier in this manual).
Bottom LED (power status) is off.	Ensure wall outlet is providing AC power: obtain another electrical device known to be working, and plug it into that AC wall outlet. <ul style="list-style-type: none">■ If other device does not work, AC power is not available at that wall outlet. Get help from building services.■ If other device does work, AC power is available from that outlet.

Symptom	Corrective action
Film starts and stops during scanning.	<ol style="list-style-type: none"> 1. Increase memory allocation for scanning software. (Especially if scanning at high resolutions, memory allocation must be sufficient to accept data stream from digitizer.) 2. If scanning to disk, ensure sufficient space is available on disk drive. 3. Ensure PC has enough memory available to support scanning application. Close applications not needed for image acquisition from digitizer. 4. If problem persists, get qualified technical help.
Digitizer stops scanning and PC locks up.	<ol style="list-style-type: none"> 1. Reset entire system: <ol style="list-style-type: none"> a. Turn digitizer off. b. Shut down PC. c. Turn digitizer on. d. After digitizer all three digitizer LEDs turn solid green, turn on PC. 2. Launch scanning software on PC, then try scanning again. If problem persists, get qualified technical help. 3. Check for correct device driver installation.
Digitizer was working properly, but after installing (or reinstalling) the scanning application there are Toolkit errors or the digitizer is not detected.	<ol style="list-style-type: none"> 1. If you installed a new scanning application, or if you reinstalled the existing application. Install the VSCAN Drivers from the Installation CD (see appropriate section in the "Installing device drivers" chapter). 2. If problem persists, contact support@iberisoft.com
Digitizer is not listed in Windows™ Control Panel under Scanners and Cameras.	<ol style="list-style-type: none"> 1. Update VSCAN drivers. See the Installation Guide. 2. Check all cables and connectors.
Digitizer is not detected.	<ol style="list-style-type: none"> 1. Check all cables and connectors. 2. Reset entire system: <ol style="list-style-type: none"> a. Turn digitizer off. b. Shut down PC. c. Turn digitizer on. d. After digitizer all three digitizer LEDs turn solid green, turn on PC.
Auto Feeder does not reliably feed films.	<ol style="list-style-type: none"> 1. Clean the lift roller on the Feeder.

Note: The use of portable or mobile communications equipment and/or the presence of strong electromagnetic and/or x-ray fields may interfere with proper operation of this product. This product should not be used adjacent to or stacked with other equipment. If adjacent or stacked use is necessary, verify normal operation in the configuration in which it will be used. Should such interference occur, the user is required to provide adequate isolation between the digitizer and the source of the interference. Isolation is typically achieved by moving the digitizer away from the source of the interference.

Weights and Dimensions

Shipping weight and dimensions

Shipping dimensions	24" wide x 29" deep x 24" high 610mm x 737mm x 610mm
Shipping weight	60 lb 27 kg

Digitizer weight and dimensions:

Overall dimensions	19" wide x 23" deep x 29.25" high 483mm x 584mm x 743mm
Footprint	19" wide x 23" deep 483mm x 584mm
Weight	45 lb 21 kg

Packing the Film Digitizer for Shipment

IMPORTANT: When shipping the film digitizer, you **must** use the original packing materials, including wire ties, plastic bags, plastic wrap, foam supports and cartons. Improper packaging may allow damage to the digitizer, which will incur additional charges for repair.

1. Turn Off the Digitizer

Press “0” on the power switch.

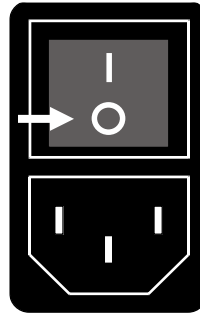

2. Disconnect the Power Cord and USB Cable

- a. Disconnect the power cord from the Power Entry Module on the rear of the digitizer.
- b. Disconnect the USB cable from the rear of the digitizer.

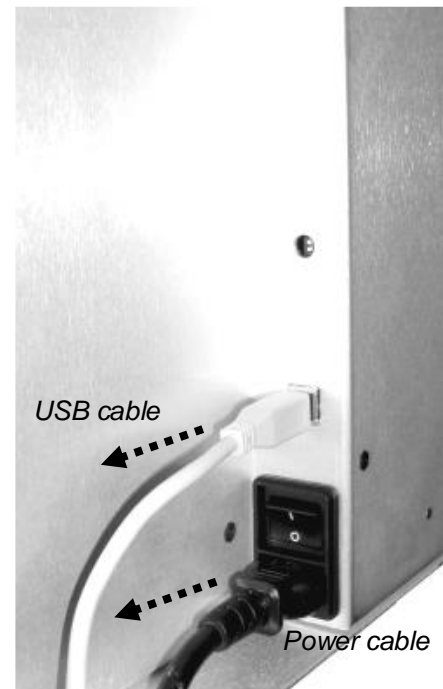

3. Remove the Exit Tray from the Digitizer Base

Lift the exit tray up to disengage it from the plastic edge just below the rollers, and then pull it gently toward you.



4. Remove the Feeder from the Digitizer Base

- a. Remove the film support bar from the top of the feeder

b.

Note: You must remove the film support before packing the feeder; otherwise the feeder will not fit into the foam support

Screws

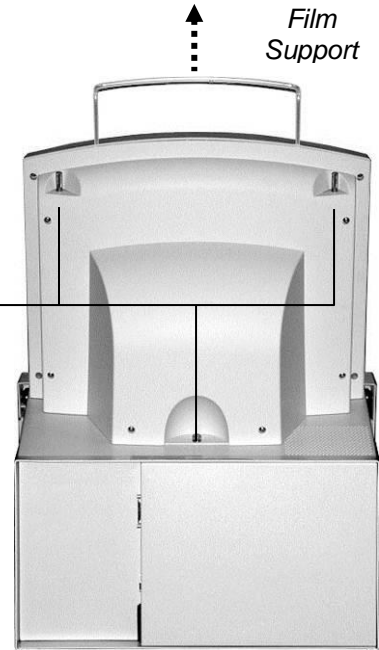

- c. Loosen the three thumbscrews securing the feeder to the digitizer base.

- d. Lift the feeder up and off the digitizer base.

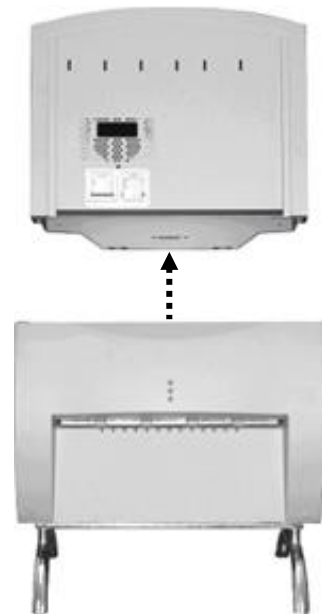

5. Remove the Digitizer Base from the Stand

Loosen the thumbscrews on the bottom of the stand, and then lift the digitizer base from the stand.

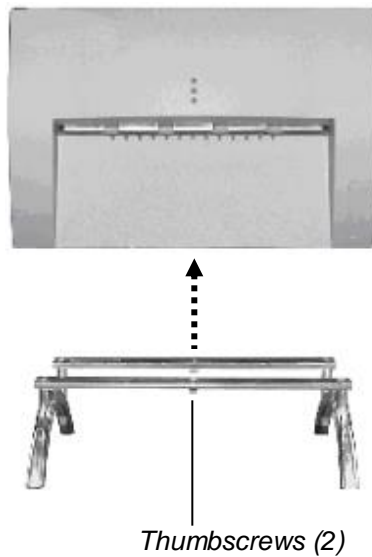

6. Wrap Certain Items

- a. Insert the foam block in the rear of the digitizer base.

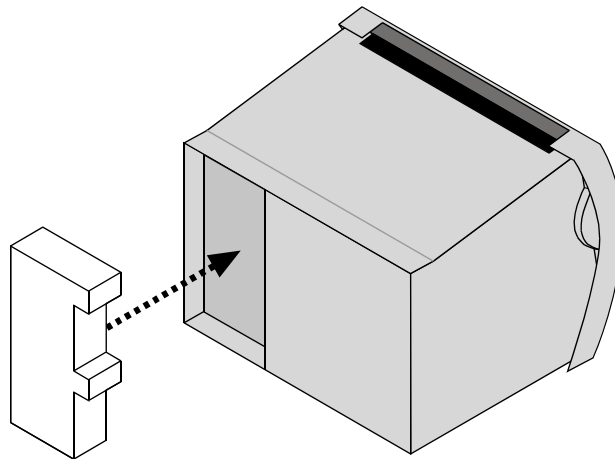

- b. Place the digitizer base in a plastic bag. Seal the bag with tape.
- c. Place the film feeder in a plastic bag. Seal the bag with tape.
- d. Place the exit tray in a plastic bag. Seal the bag with tape.
- e. Place the film support bar in a padded bag. Seal the bag with tape.

7. Pack the Accessory Box

- a. Place these items in the accessory box in the order shown here. Orient the items as shown. When the cardboard retainer is in place, the two runners on the exit tray should protrude through the two slots in the retainer.

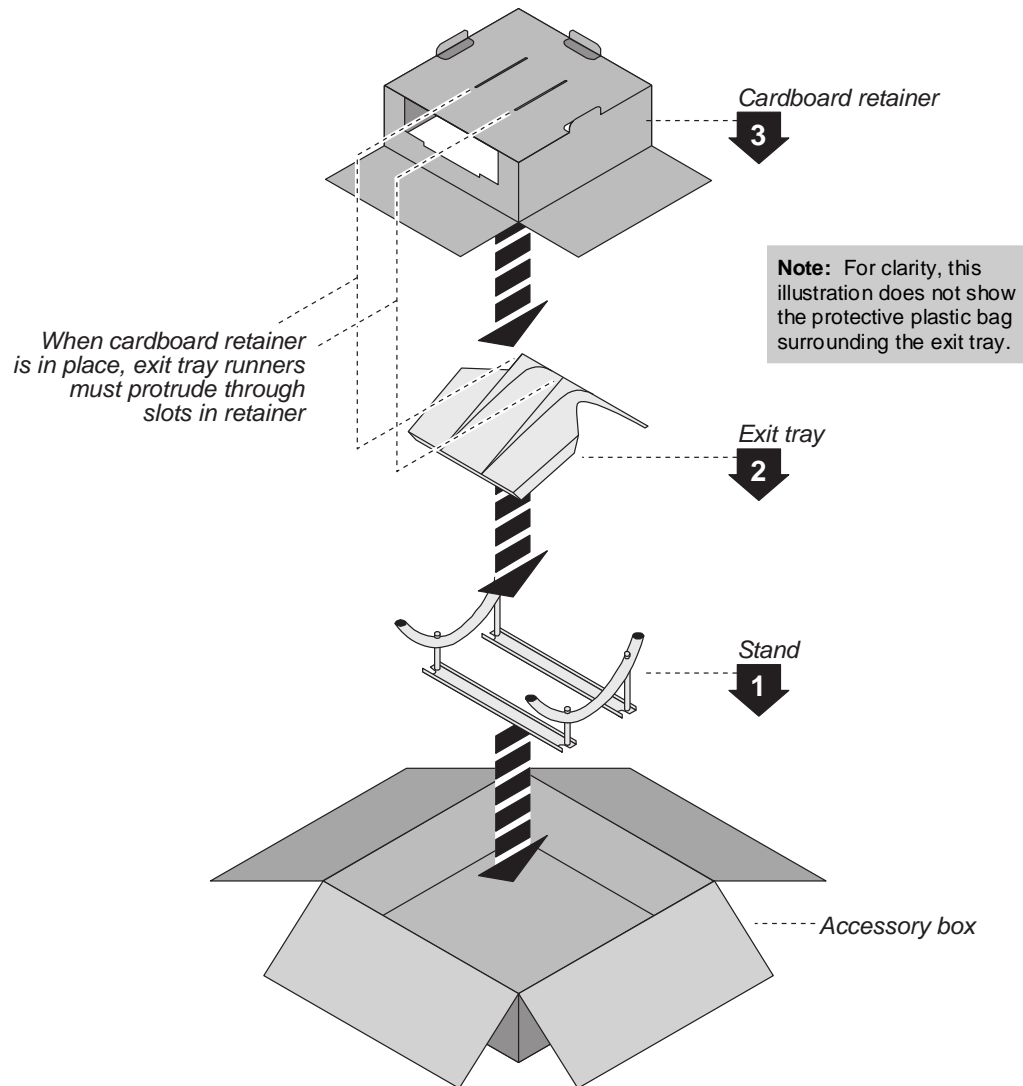

b. Place cables on the cardboard retainer:

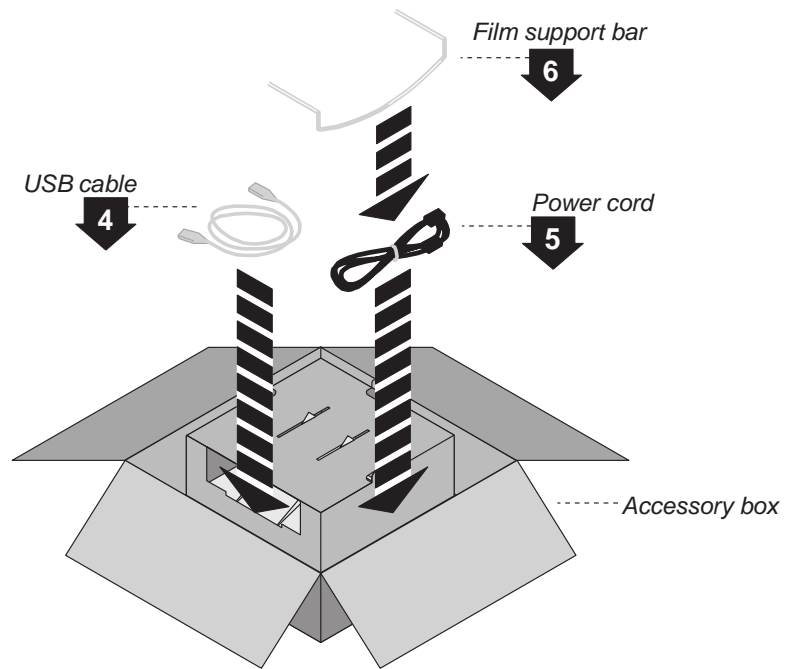

c. Close the accessory box and seal it with tape.

8. Pack the Shipping Carton

- a. Place the items shown in the shipping carton, as shown here. Orient the items as shown.

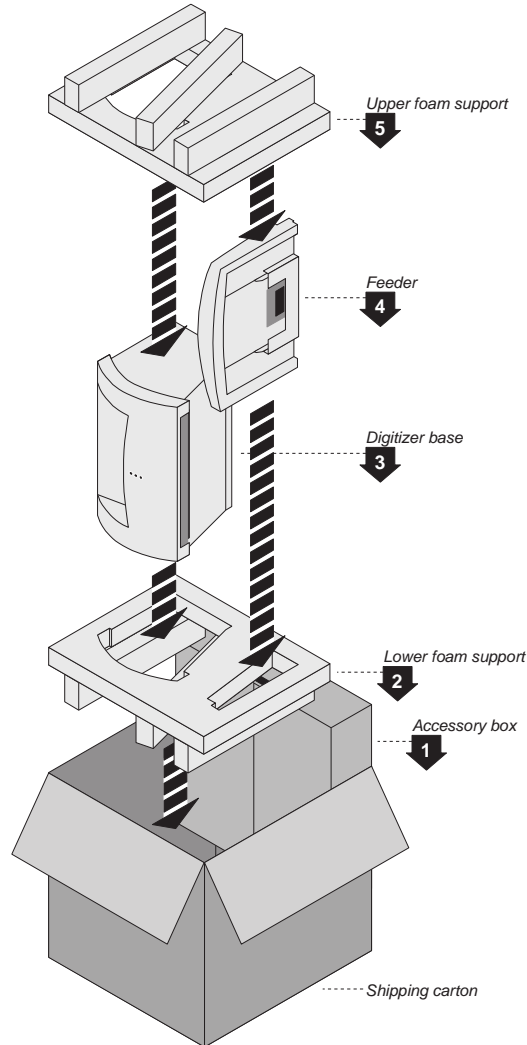

Note: For clarity, this illustration does not show the plastic bags surrounding the digitizer and feeder.

- b. Close the shipping carton and seal it with tape.

Note: If you are shipping the digitizer for repair or any other reason:

1. Obtain a Returned Materials Authorization (RMA) number by sending an e-mail request to support@iberisoft.com. Include the digitizer's serial number and the reason for return.
2. Write the RMA number on the box or shipping label. If the shipment does not have an RMA, processing will be delayed when it reaches VSCAN Technical Support.

Appendix:

Electromagnetic Guidance

Caution: Medical electrical equipment.
EMC (Electro Magnetic Compatibility) must be considered before any medical electrical equipment is installed or put into service. Follow the information in the accompanying documentation when installing and operating the VSCAN Digitizer.

Caution: Portable or mobile RF communication equipment can effect Medical Electrical equipment.

Caution: Using the Digitizer adjacent to or stacked with other equipment may cause interference between the equipment. Before utilizing stacked or adjacent equipment, verify proper functionality of all equipment in the actual configuration in which it will operate.

Caution: Connecting the Digitizer to equipment that is not rated CISPR 11 class A or class B may alter the electromagnetic characteristics.

Caution: In a domestic environment this product may cause radio interference in which case the user may be required to take adequate measures.

Guidance and manufacturer's declaration – electromagnetic equipment

Emissions test	Compliance	Electromagnetic environment - guidance
RF Emissions	Group 1	The Digitizers use RF energy only for their internal functions. Therefore, its RF emissions are very low and are not likely to cause any interference in nearby electronic equipment.
CISPR11	Class A	The Digitizers are suitable for use in all establishments other than domestic and those directly connected to the public low voltage power supply network that supplies buildings used for domestic purposes.

Guidance And Manufacturer's Declaration – Electromagnetic Immunity Enclosure Port

The VSCAN NDTPRO Industrial Film Digitizer is intended for use in the electromagnetic environment specified below. The customer or end user of the Digitizer should assure that it is used in such an environment.

Immunity test	Test method	Immunity Test Levels Professional healthcare facility environment
Electrostatic Discharge (ESD)	IEC 61000-4-2	± 8 kV contact ± 2 kV, ±4 kV, ± 8 kV, ± 15 kV air
Radiated RF EM fields	IEC 61000-4-3	3 V/m 80 MHz – 2,7 GHz 80% AM at 1 kHz
Proximity fields from RF wireless communications equipment	IEC 61000-4-3	See Table A
Rated power frequency magnetic fields	IEC 61000-4-8	30 A/m 50 or 60 Hz

Guidance And Manufacturer's Declaration – Electromagnetic Immunity - Input a.c. power

The VSCAN NDTPRO Industrial Film Digitizer is intended for use in the electromagnetic environment specified below. The customer or end user of the Digitizer should assure that it is used in such an environment.

Immunity test	Test method	Immunity Test Levels Professional healthcare facility environment
Electrical fast transient / bursts ^{a) l) o)}	IEC 61000-4-4	± 2 kV 100 kHz repetition frequency
Surges ^{a) b) j) o)} Line-to-line	IEC 61000-4-5	± 0,5 kV, ± 1 kV
Surges ^{a) b) j) k) o)} Line-to-ground	IEC 61000-4-5	± 0,5 kV, ± 1 kV, ±2 kV
Conducted disturbances induced by RF fields ^{c) d) o)}	IEC 61000-4-6	3 V ^{m)} 0,15 MHz – 80 MHz 6 V ^{m)} in ISM bands between 0,15 MHz and 80 MHz ⁿ⁾ 80 % AM at 1 kHz ^{e)}
Voltage dips ^{f) p) r)}	IEC 61000-4-11	0 % U_T ; 0,5 cycle ^{g)} At 0°, 45°, 90°, 135°, 180°, 225°, 270°, and 315° ^{q)}
		0 % U_T ; 1 cycle and 70 % U_T ; 25/30 cycles ^{h)} Single phase: at 0°
Voltage interruptions ^{f) i) o) r)}	IEC 61000-4-11	0 % U_T ; 250/300 cycle ^{h)}

Note: U_T is the A.C. mains voltage prior to application of the test level.

Guidance And Manufacturer's Declaration – Electromagnetic Immunity - Input a.c. power Continued:

- a) The test may be performed at any one power input voltage within the ME Equipment or ME SYSTEM RATED voltage range. If the ME EQUIPMENT or ME SYSTEM is tested at one power input voltage, it is not necessary to re-test at additional voltages.
- b) All the ME EQUIPMENT and ME SYSTEM cables are attached during the test.
- c) Calibration for current injection clamps shall be performed in a 150 Ω system.
- d) If the frequency stepping skips over an ISM or amateur band, as applicable, an additional test frequency shall be used in the ISM or amateur radio band. This applies to each ISM and amateur radio band within the specified frequency range.
- e) Testing may be performed at other modulation frequencies identified by the RISK MANAGEMENT PROCESS.
- f) ME EQUIPMENT and ME SYSTEMS with a d.c. power input intended for use with a.c. - to - d.c. converters shall be tested using a converter that meets the specifications of the MANUFACTURER of the ME EQUIPMENT or ME SYSTEM. THE IMMUNITY TEST LEVELS are applied to the a.c. power input of the converter.
- g) Applicable only to ME EQUIPMENT and ME SYSTEMS connected to single-phase a.c. mains.
- h) E.g. 10/12 means 10 periods at 50 Hz or 12 periods at 60 Hz.
- i) ME EQUIPMENT and ME SYSTEMS with RATED input current greater than 16 A / phase shall be interrupted one for 250/300 cycles at any angle and at all phases at the same time (if applicable). ME EQUIPMENT and ME SYSTEMS with battery backup shall resume line power operation after the test. For ME EQUIPMENT and ME SYSTEMS with RATED input current not exceeding 16 A, all phases shall be interrupted simultaneously.
- j) ME EQUIPMENT and ME SYSTEMS that do not have a surge protection device in the primary power circuit may be tested only at ± 2 kV line(s) to earth and ± 1 kV line(s) to line(s).
- k) Not applicable to CLASS II ME EQUIPMENT and ME SYSTEMS.
- l) Direct coupling shall be used.
- m) r.m.s., before modulation is applied.
- n) The ISM (industrial, scientific and medical) bands between 0,15 MHz and 80 MHz are 6,765 MHz to 6,795 MHz; 13,553 MHz to 13,567 MHz; 26,957 MHz to 27,283 MHz; and 40,66 MHz to 40,70 MHz. The amateur radio bands between 0,15 MHz and 80 MHz are 1,8 to 2,0 MHz, 3,5 MHz to 4,0 MHz, 5,3 MHz to 5,4 MHz, 7 MHz to 7,3 MHz, 10,1 MHz to 10,15 MHz, 14 MHz to 14,2 MHz, 18,07 MHz to 18,17 MHz, 21,0 MHz to 21,4 MHz, 24,89 MHz to 24,99 MHz, 28,0 MHz to 29,7 MHz and 50,0 MHz to 54,0 MHz.
- o) Applicable to ME EQUIPMENT and ME SYSTEMS with RATED input current less than or equal to 16 A / phase and ME EQUIPMENT and ME SYSTEMS with RATED input current greater than 16 A / phase.
- p) Applicable to ME EQUIPMENT and ME SYSTEMS with RATED input current less than or equal to 16 A / phase.
- q) At some phase angles, applying this test to ME EQUIPMENT with transformer mains power input might cause an overcurrent protection device to open. This can occur due to magnetic flux saturation of the transformer core after the voltage dip. If this occurs, the ME EQUIPMENT or ME SYSTEM shall provide BASIC SAFETY during and after the test.
- r) For ME EQUIPMENT and ME SYSTEMS that have multiple voltage settings or auto ranging voltage capability, the test shall be performed at the minimum and maximum RATED input voltage. ME EQUIPMENT and ME SYSTEMS with a RATED input voltage range of less than 25 % of the highest RATED input voltage shall be tested at one RATED input voltage within the range.

Immunity to proximity fields from RF wireless communications equipment

The ENCLOSURE PORT of ME EQUIPMENT and ME SYSTEMS shall be tested as specified in Table A using the test methods specified in IEC 61000-4-3.

The frequencies and services listed in Table A are representative examples that are based on RF communications equipment in use at the time of publication of this collateral standard. The test specification does not attempt to cover every frequency and service used in every country. The RISK MANAGEMENT PROCESS should take current communications services into account. Testing should be performed at the additional frequencies identified that are not represented in Table A.

While communication might not be possible when ME EQUIPMENT that includes radio equipment is tested in its bandwidth, the ME EQUIPMENT or ME SYSTEM shall still be able to provide its BASIC SAFETY and ESSENTIAL PERFORMANCE.

Table A- Test specifications for Enclosure Port immunity to RF wireless communications equipment.

The customer or the user of the VSCAN NDT^{PRO} Industrial Film Digitizer can help prevent electromagnetic interference by maintaining a minimum distance between portable and mobile RF communications equipment (transmitters) and the Digitizer as recommended below, according to the maximum output power of the communications equipment.

Test frequency (MHz)	Modulation ^{a)}	Maximum power (W)	Distance (m)	Immunity Test Level (V/m)
385	Pulse modulation 18 Hz	1,8	0,3	27
450	FM ^{b)} ±5 kHz deviation 1 kHz sine	2	0,3	28
710	Pulse modulation 217 Hz	0,2	0,3	9
745				
780				
810	Pulse modulation 18 Hz	2	0,3	28
870				
930				
1 720	Pulse modulation 217 Hz	2	0,3	28
1 845				
1 970				
2 450	Pulse modulation 217 Hz	2	0,3	28
5 240	Pulse modulation 217 Hz	0,2	0,3	9
5 500				
5 785				

NOTE: If necessary to achieve the Immunity Test Level, the distance between the transmitting antenna and the ME Equipment or ME System may be reduced to 1 m. The 1 m test distance is permitted by IEC 61000-4-3

- a) The carrier shall be modulated using a 50% duty cycle square wave signal.
- b) As an alternate to FM modulation, 50% pulse modulation at 18 Hz may be used because while it does not represent actual modulation, it would be worst case.

The Manufacturer should consider reducing the minimum separation distance, based on RISK MANAGEMENT, and using higher IMMUNITY TEST LEVELS that are appropriate for the reduced minimum separation distance. Minimum separation distances for higher IMMUNITY TEST LEVELS shall be calculated using the following equation:





$$E = \frac{6}{d} \sqrt{P}$$

Where *P* is the maximum power in W, *d* is the minimum separation distance in m, and *E* is the IMMUNITY TEST LEVEL in V/m.

If the ME EQUIPMENT or ME SYSTEM complies with the higher IMMUNITY TEST LEVELS for this test, the 30 cm minimum separation distance (per above table) may be replaced with minimum separation distances calculated from the higher IMMUNITY TEST LEVELS.

Appendix:

Symbols

Symbol	Description
	Indicates the need for the user to consult the instructions for use for important cautionary information such as warnings and precautions that cannot, for a variety of reasons, be presented on the device itself.
	Indicates the need for the user to consult the instructions for use.
	Compliance to EU Directives
	This symbol on the product indicates that this product must not be disposed of as unsorted municipal waste. Instead it is your responsibility to dispose of your waste equipment by handing it over to a designated collection point for recycling of waste electrical and electronic equipment. For more information about where you can dispose of your waste equipment for recycling please contact your local city office, your household waste disposal service or the shop where you purchased the product.
	This symbol on the product indicates that this product does not use certain hazardous substances.



IBERIS

S O F T W A R E

**Av. Flórez Estrada, 9,
office 1A**

Phone:

Web:

Email:

**33180 Noreña, Asturias,
Spain**

+34 984 030 851

www.iberisoft.com

support@iberisoft.com